

Montageanleitung

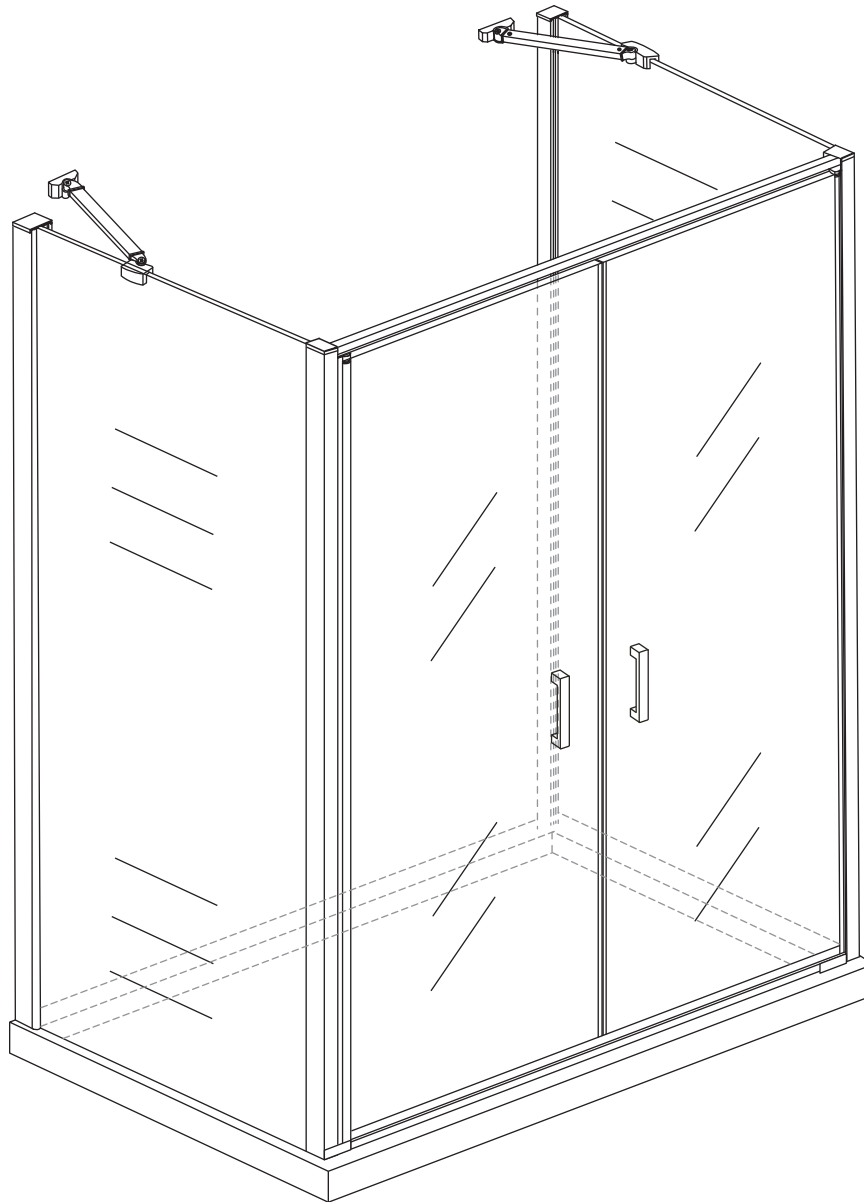

23322/23323/23324/23326
23431/23432/23433/23434

RoHS **CE** ISO9001:2008

Benötigtes Werkzeug

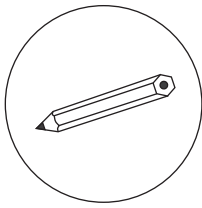

Bleistift

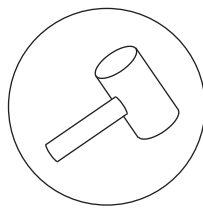

Gummi Hammer

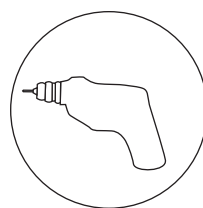

Bohrmaschine

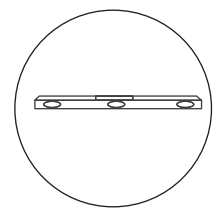

Wasserwaage

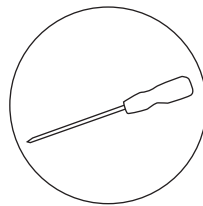

Kreuz-Schraubenzieher

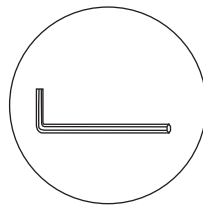

Imbusschlüssel

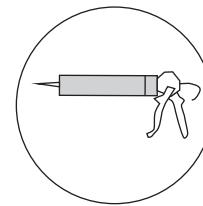

Silikon

Teilleiste

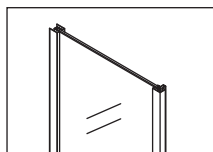

Glas-Tür

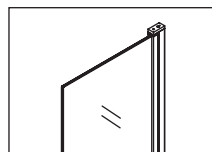

Glas-Tür

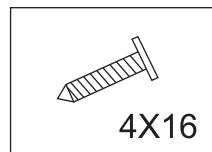

4X16

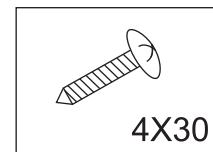

4X30

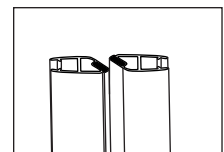

8FX-2A

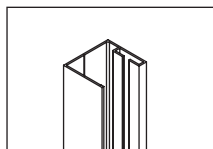

KQ-58

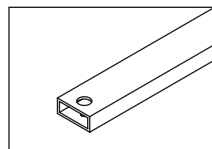

LT-45

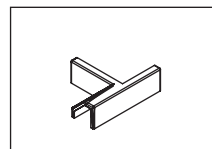

PJ-4894

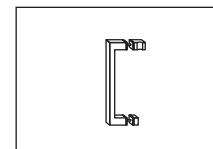

LS-1117

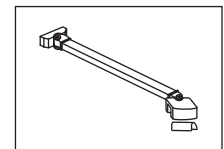

LG-2008

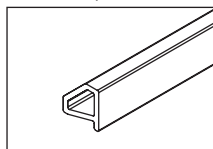

LT-05

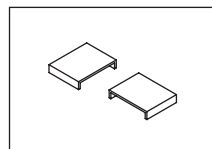

PJ-4893

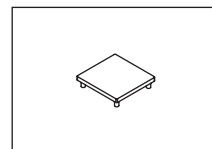

PJ-4892

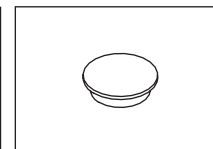

PJ-4685

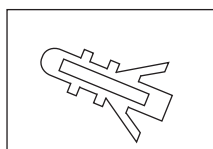
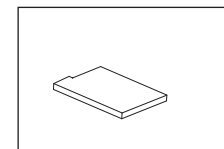

Wand-Dübel



Dübel sind nicht für alle Mauerwerke geeignet

| SIZE | L1 |
|-------------|-----|
| 800x800mm | 760 |
| 900x900mm | 860 |
| 1000x1000mm | 960 |

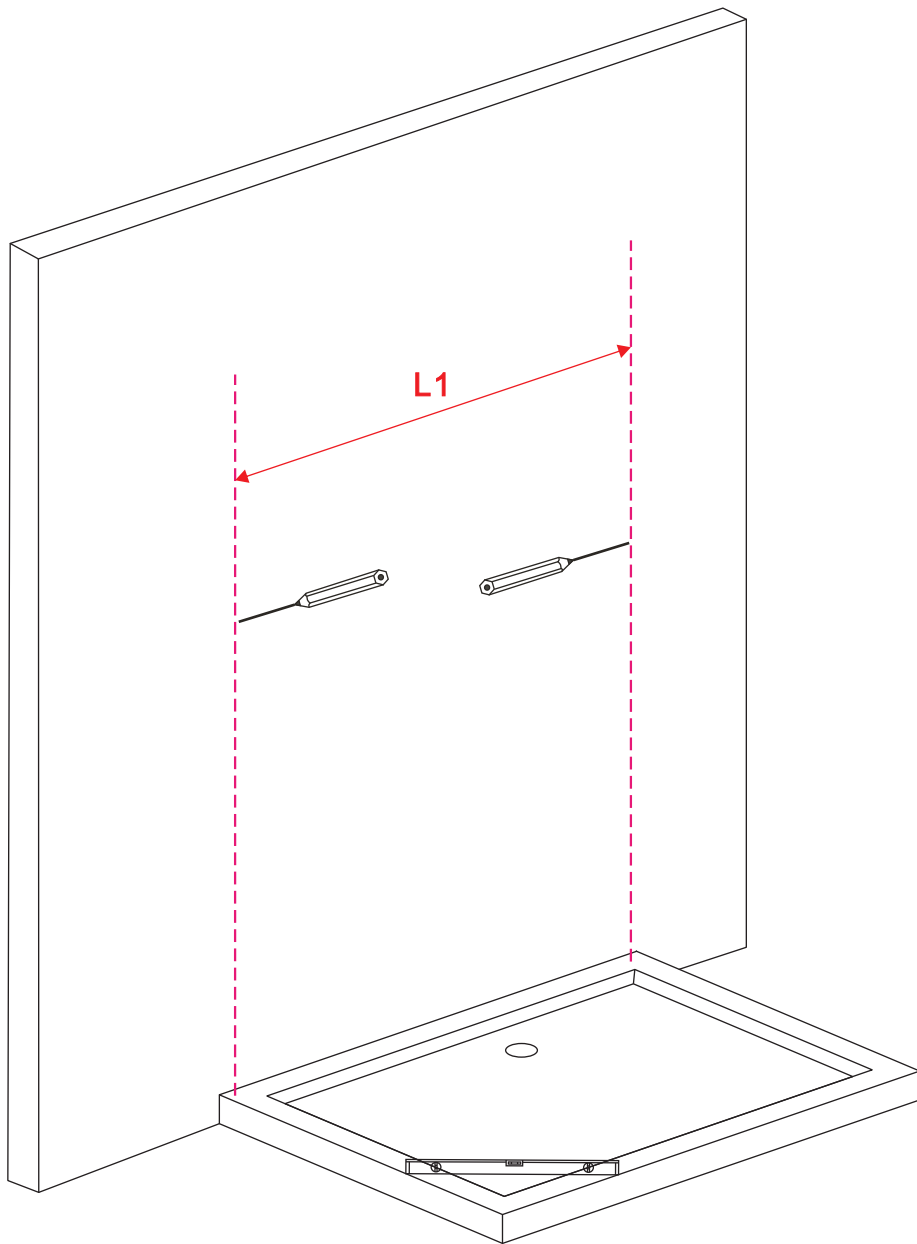

1. Platzieren Sie Duschtasse
2. Stellen Sie die Wandprofile vertikal auf und nehmen Sie eine Wasserwaage zur Hilfe (Bitte beachten Sie den Montagehinweis)
3. Markieren Sie die Bohr-Löcher
4. Bohren Sie an der Markierung und setzen Sie die dübel
5. Schrauben Sie die profile and die wand

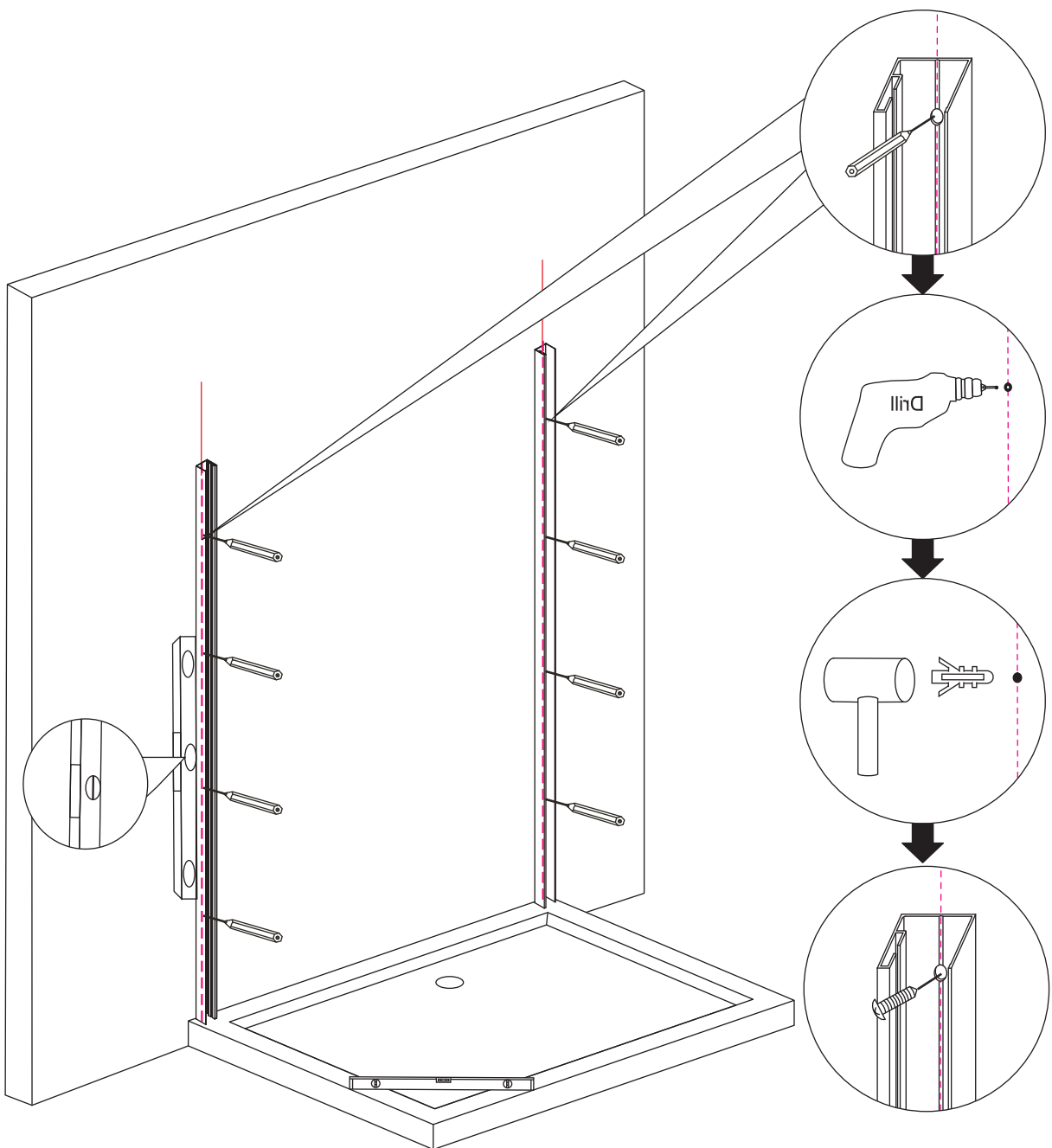
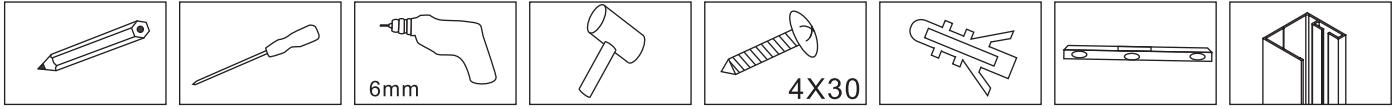

Führen Sie die feststehenden Glas-Elemente in die jeweiligen Wand-Profile
(der Anschlag ist frei wählbar)

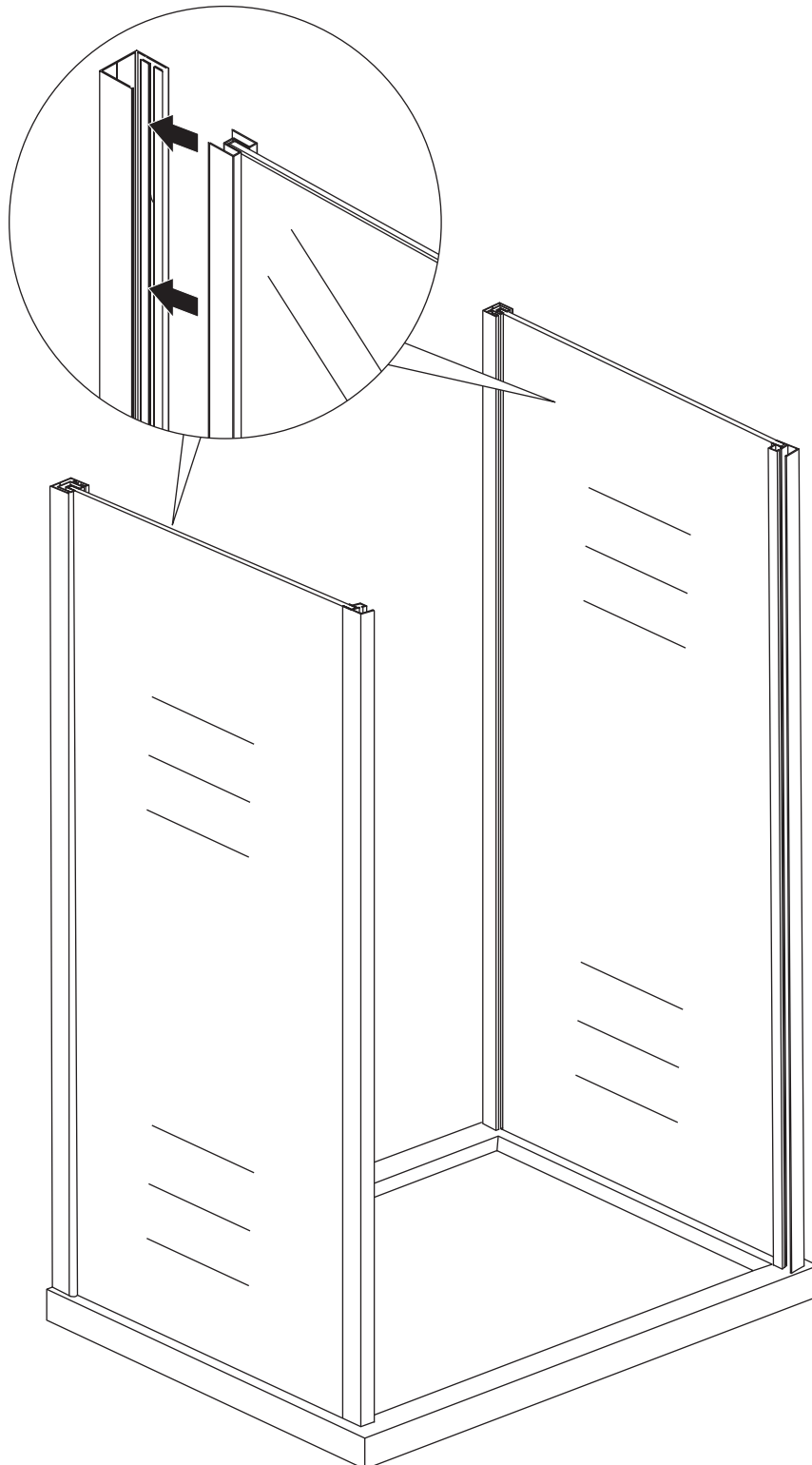
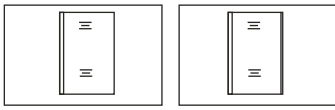

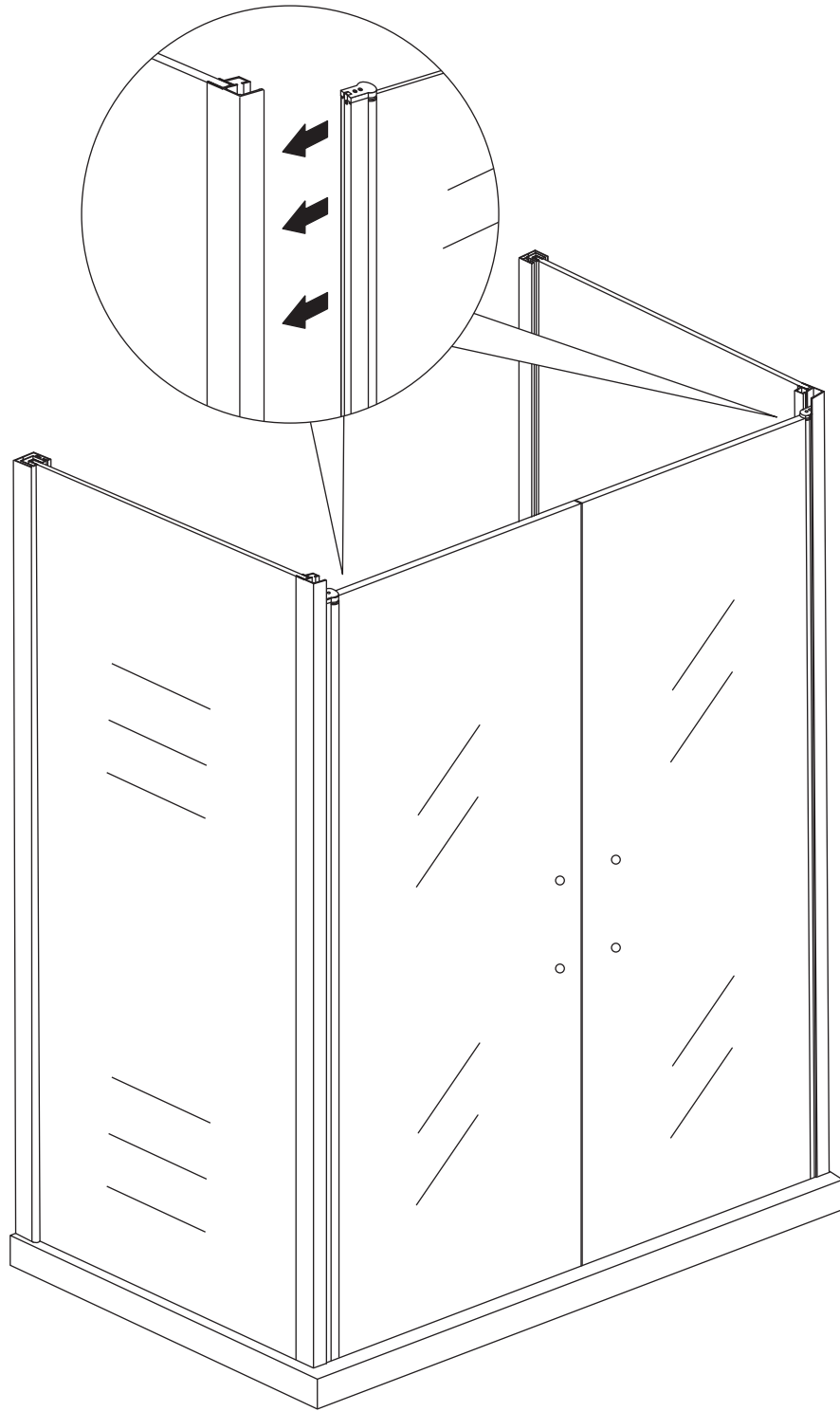
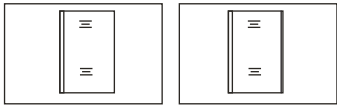

1. Installieren Sie die Stabilisationsstangen wie abgebildet
2. Verschrauben Sie den Türknauf.

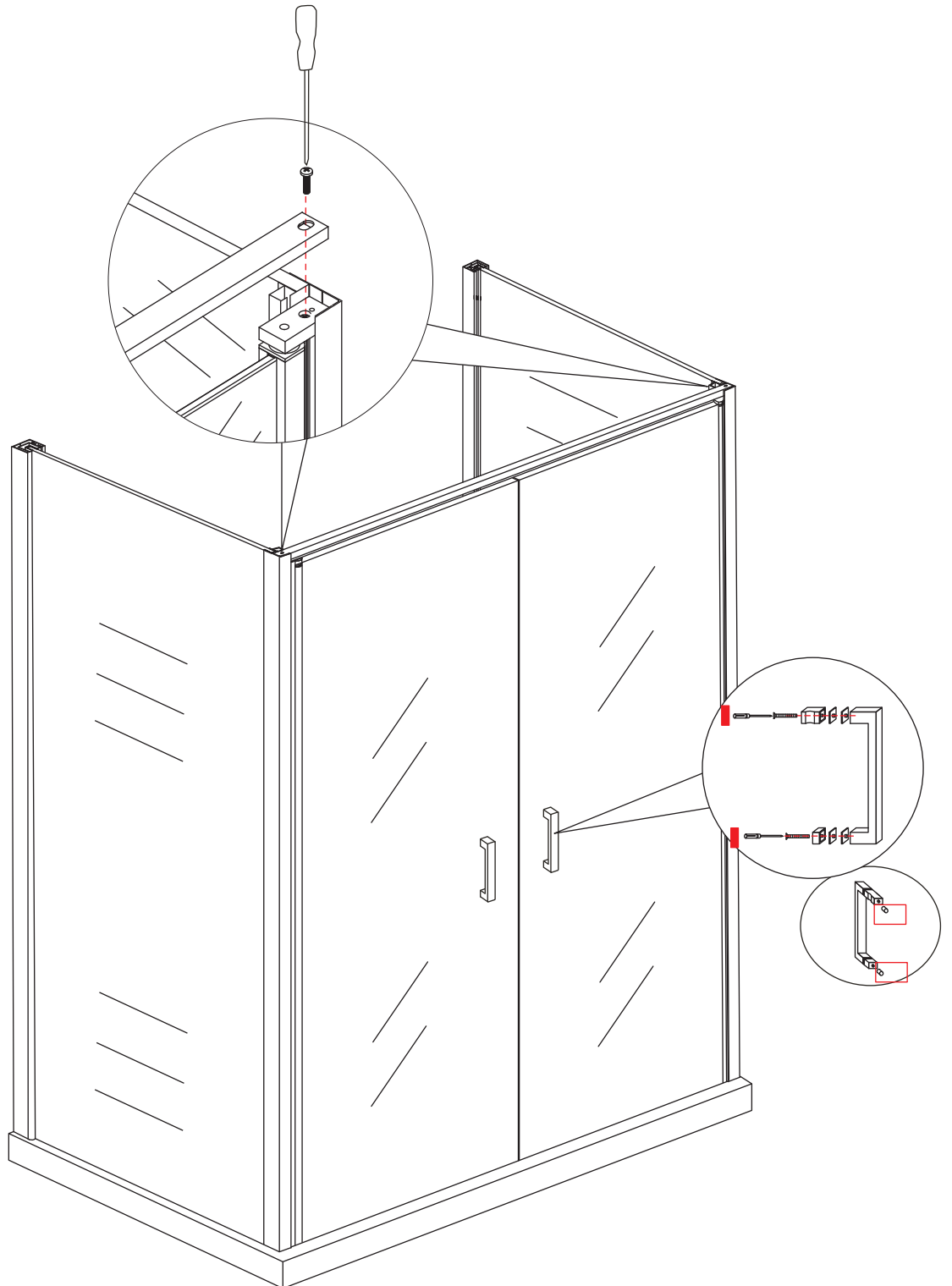
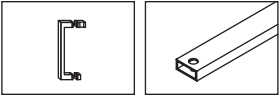

Installieren Sie die Stabilisationsstange wie abgebildet.

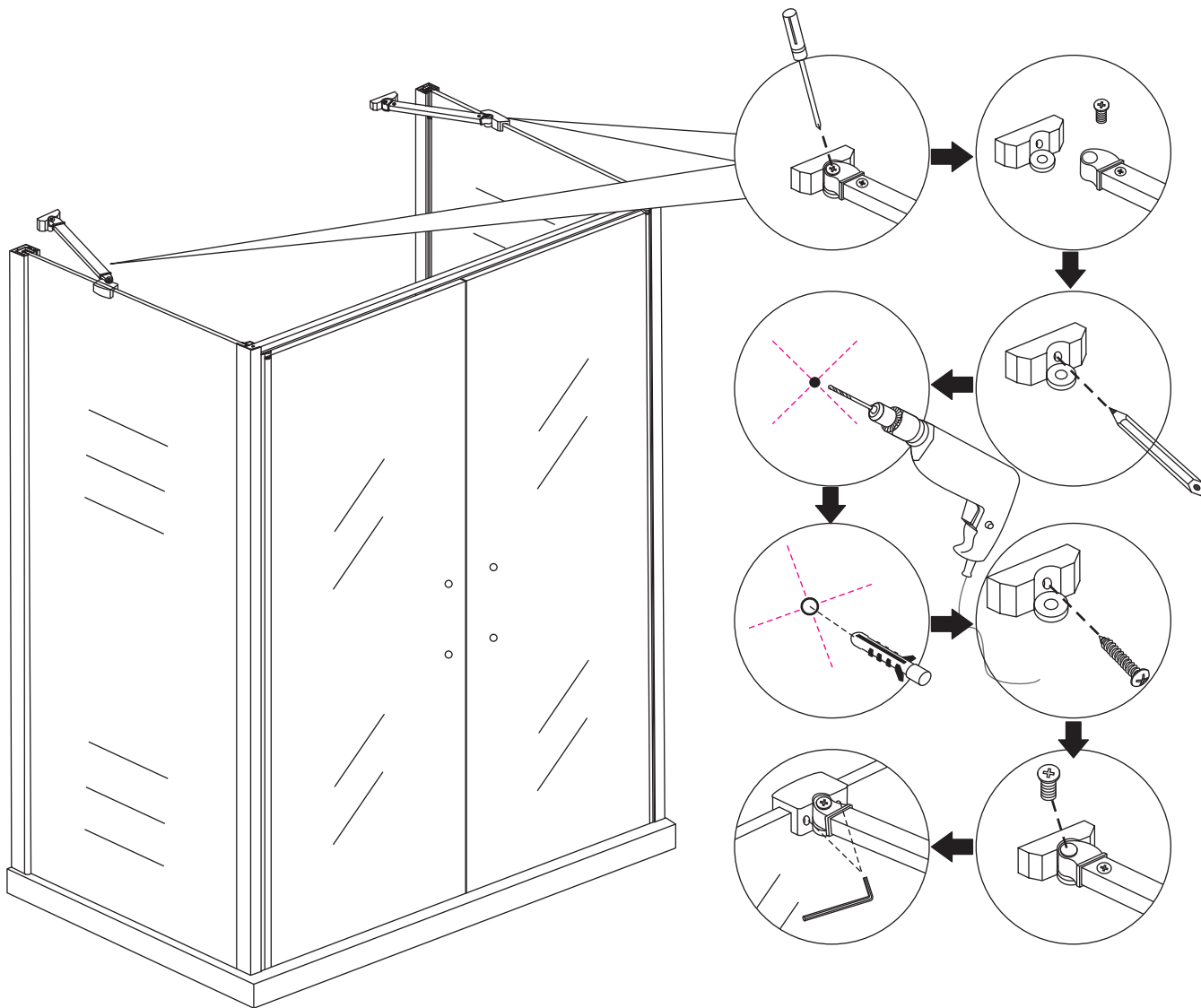
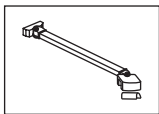

1. Installieren Sie die oberen Profil Abdeckungen gemäß nachfolgendem Bild
2. Kleben Sie die Schwalleiste mittels Silikon vor der Tür auf die Duschwanne, ggf. auf den Fliesenboden (bitte nicht Verschrauben)

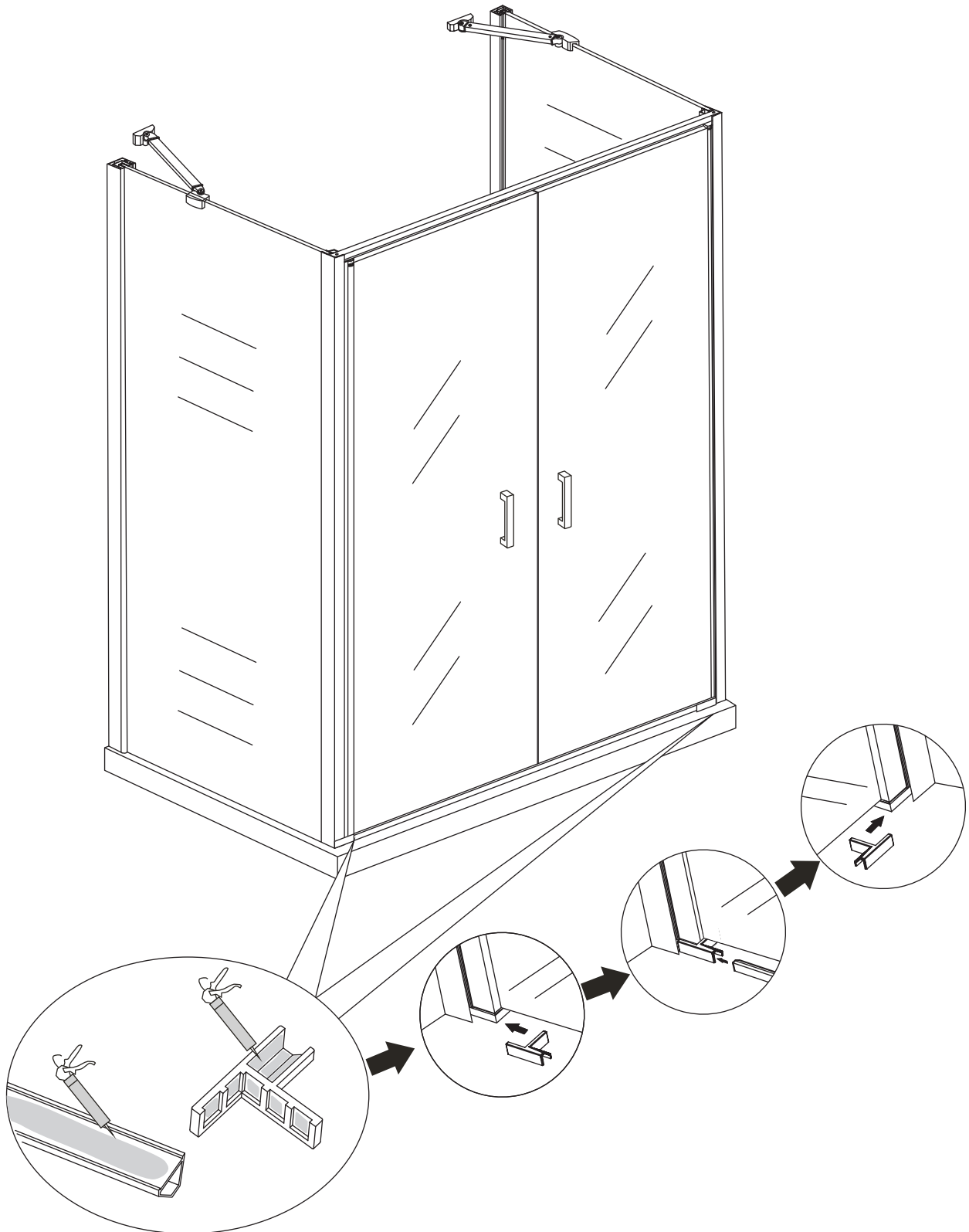
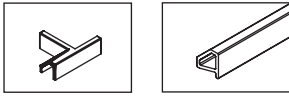

Bringen Sie die unteren Tür- & Magnetdichtungen entsprechend der Abbildung an. Passen Sie die Dichtungen so an, dass zwischen Rundprofil und unterer Dichtung keine Lücke entsteht, schneiden Sie die Dichtung ggf. zu. Lassen Sie die Dichtung zum Einstieg hin überstehen, die Magnetleisten werden von oben auf „stoß „ gesenkt

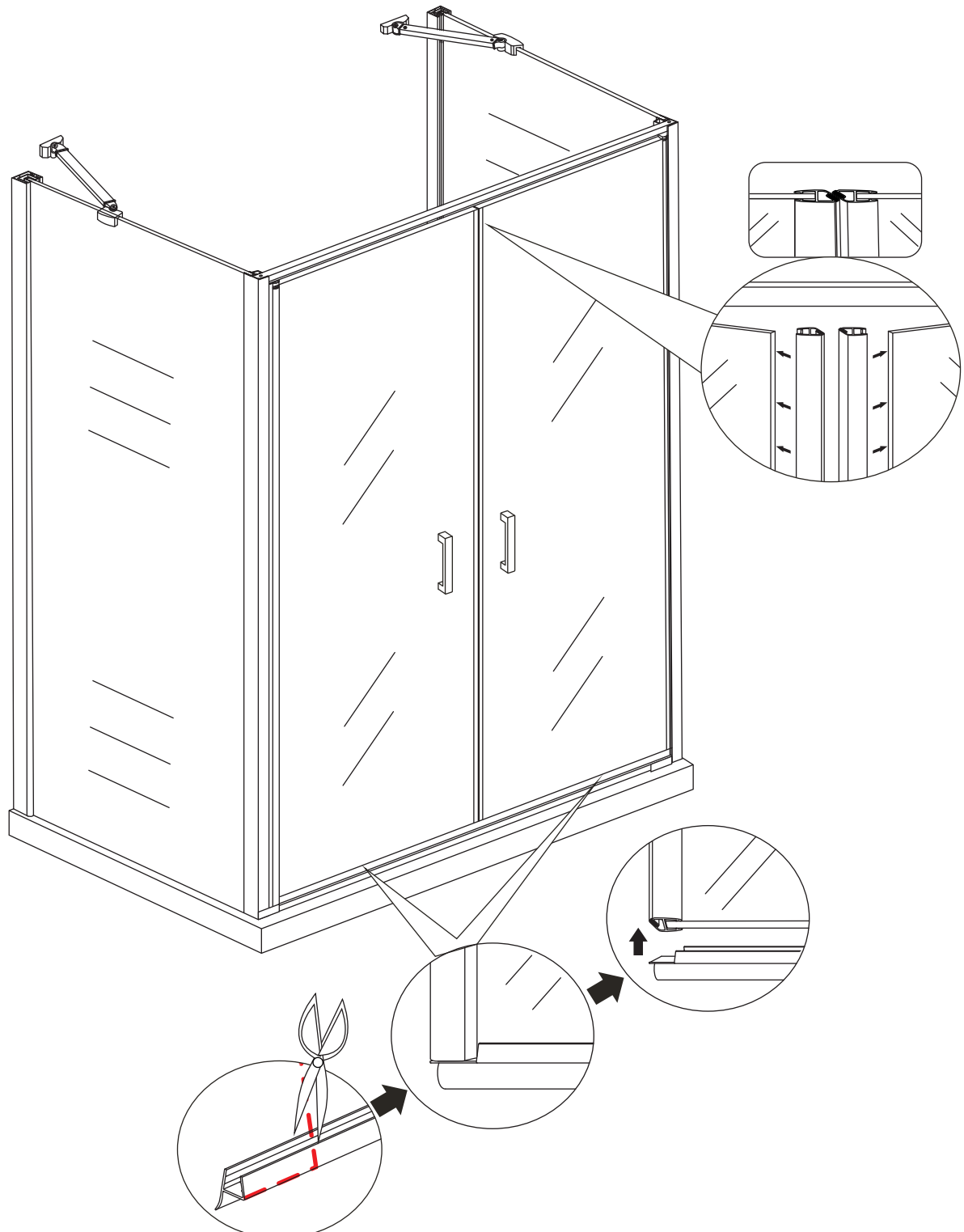
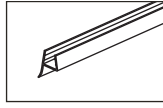
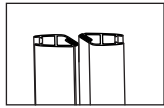

1. Bringen Sie anschließend die Abdeckkappen zwecks Verdeckung der Schrauben an.

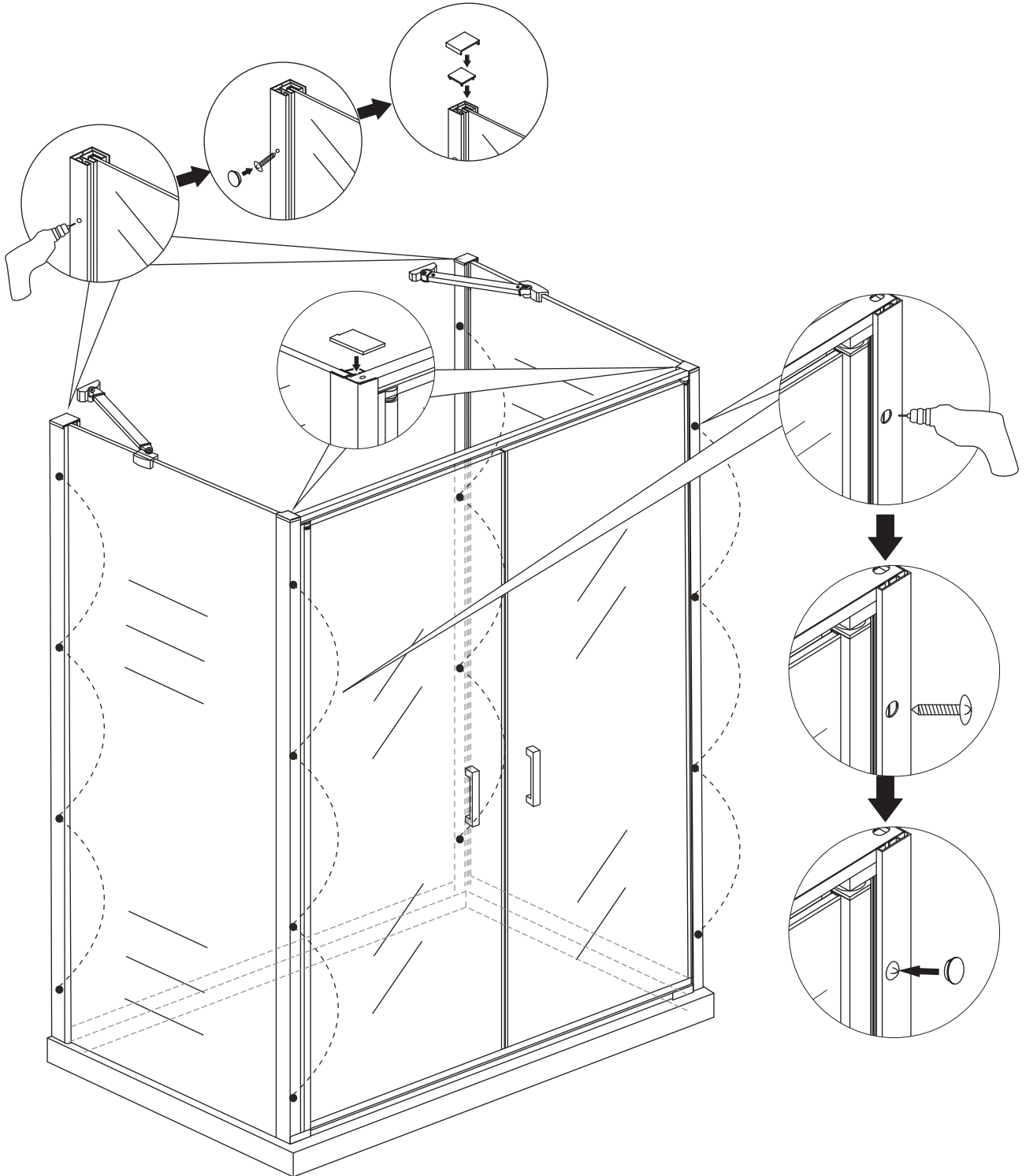
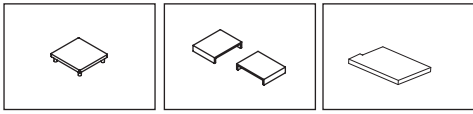

1. Versiegeln Sie die feststehenden Elemente mit Silikon sowie die Wandprofile von innen & außen

