

INSTALLATION MANUAL

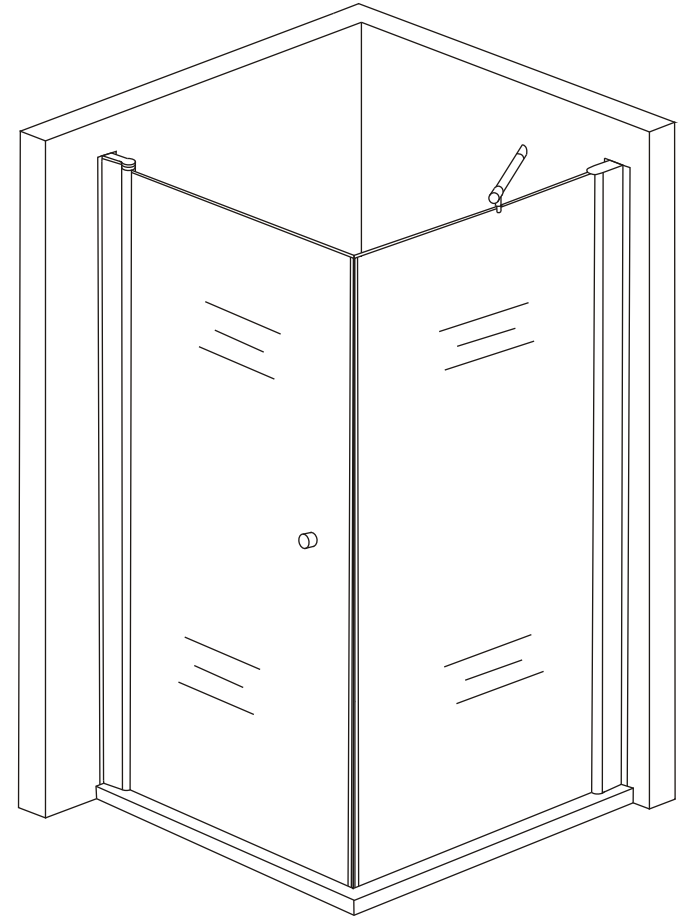

3005/3006

RoHS **CE** ISO9001:2000

TOOL PICTURE

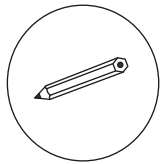

Pencil

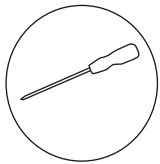

Cross screw driver

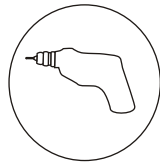

Drill machine

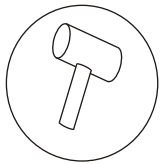

Rubber hammer

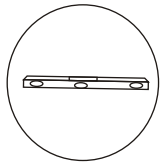

Level ruler

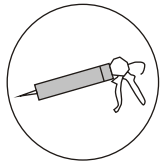

Silicon gel

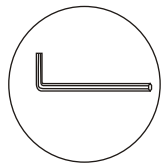

Inner hexagon spanner
(In the package)

Accessory list

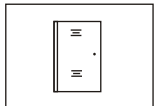

Glass

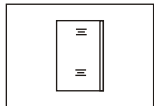

Glass

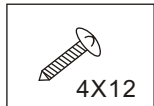

Screw

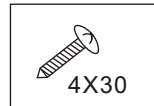

Screw

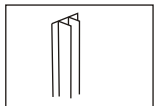

Wall profile

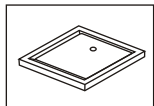

Tray

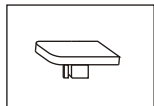

PJ-4509



CT-8BMX90

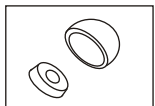

PJ-4553

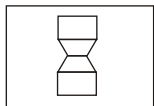

LS-1201

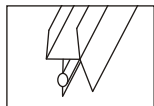

CT-8YXJT-029 Expand tube

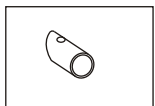
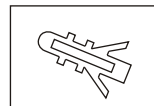

PJ-4317

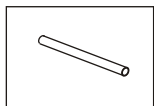

LG-2004

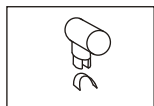

PJ-4416

1. Use 3.2mm drill bit to make two holes on the aluminium and use screws to fix.
2. Install handle on the door.
3. Cover the cap for aluminium profile.
4. Install the water-proof gasket at the bottom of glass door. (Cut the length and angle of the water-proof gasket according to the actual situation, then install it.)
5. Use silicon gel to seal the gap between fixe glass and shower tray.

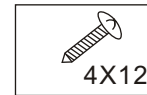

4X12

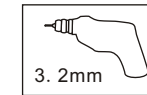
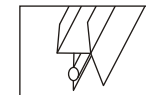
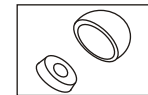

3.2mm

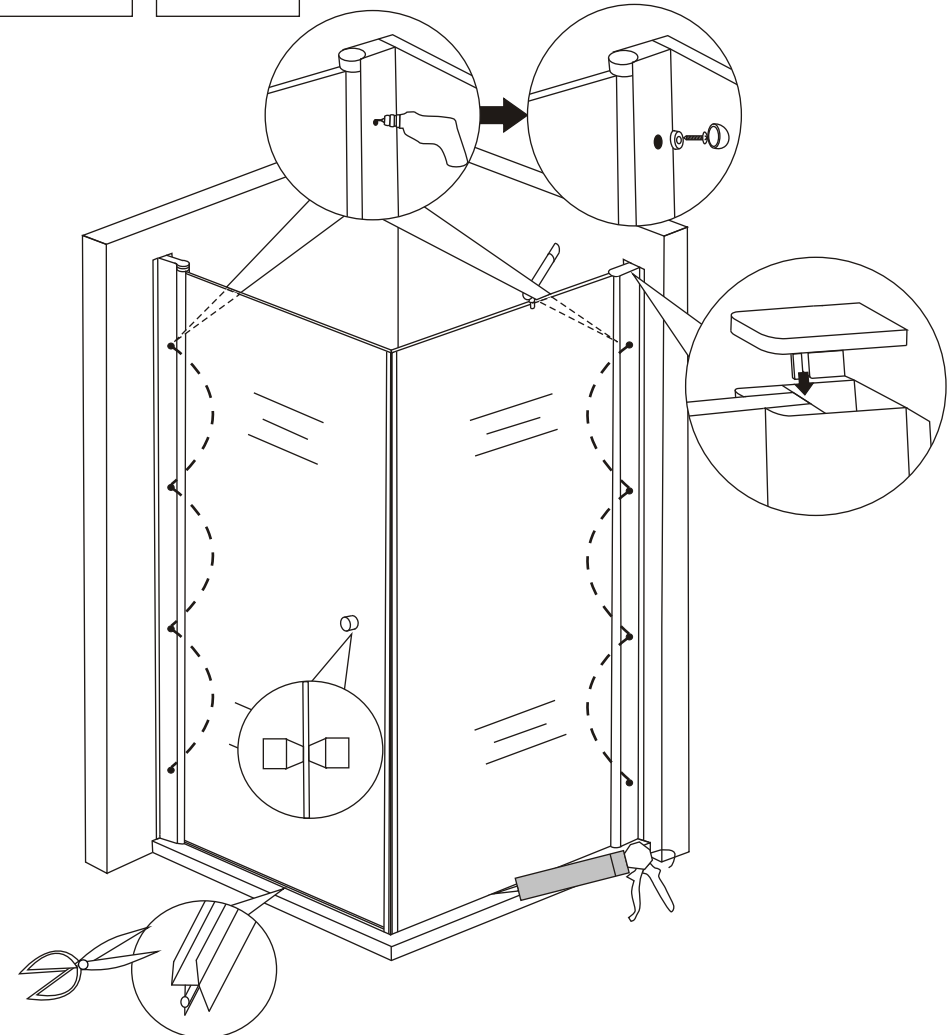
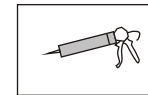
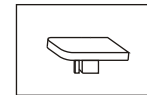
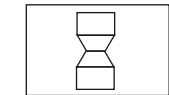

1. Install the top support bar. Firstly, use 6mm drill bit to make hole for joint. as the position on the picture, then put screw inner spacer in the hole, fix the screw finally.
2. Install the other rest parts of support bar.

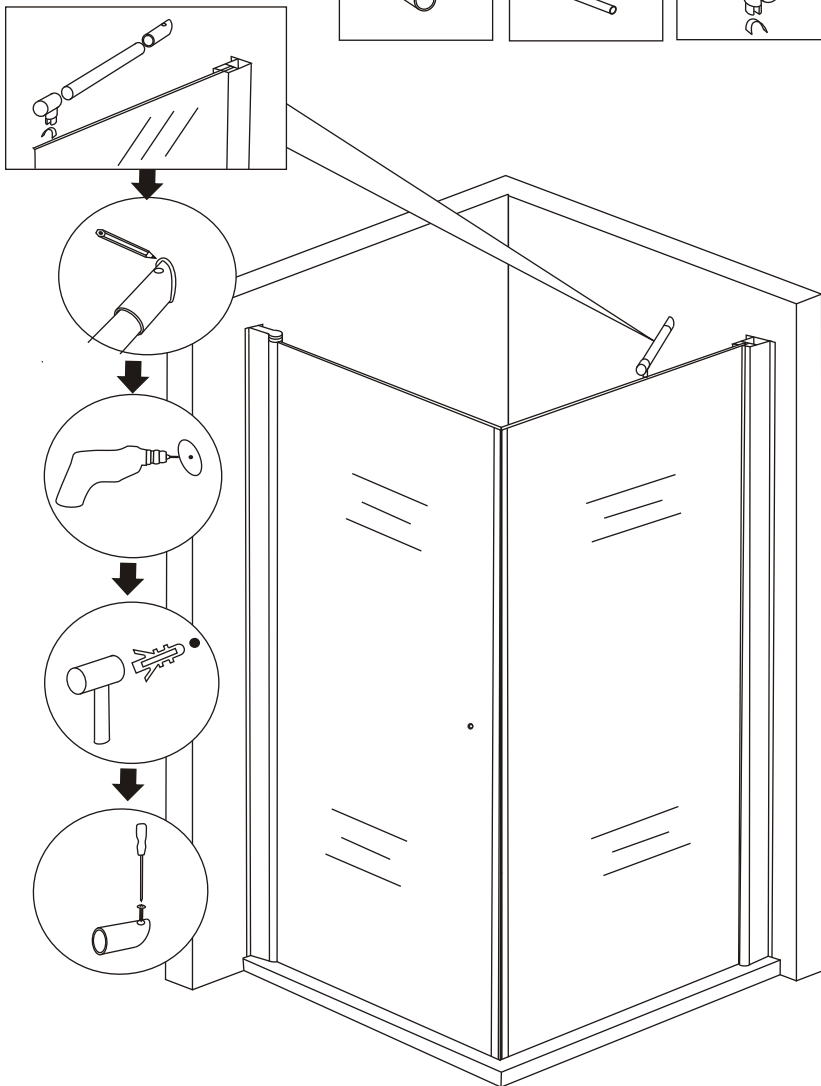
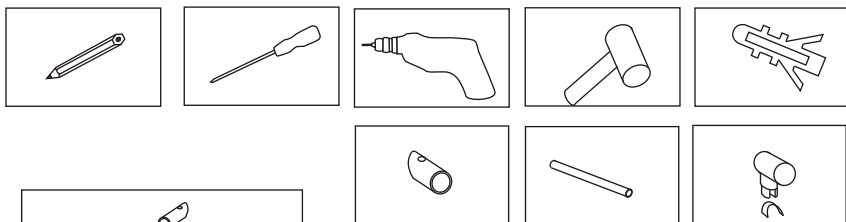

1. Put tray on the installation position, fill the tray and floor with filler (Do not use pure cement)
2. Put aluminium profile on the wall and use level ruler to make it straight.
3. Use pencil draw holes on the wall.
4. Use 6mm drill bit to make holes on the wall.
5. Insert screw space pipe in the wall and screw it.

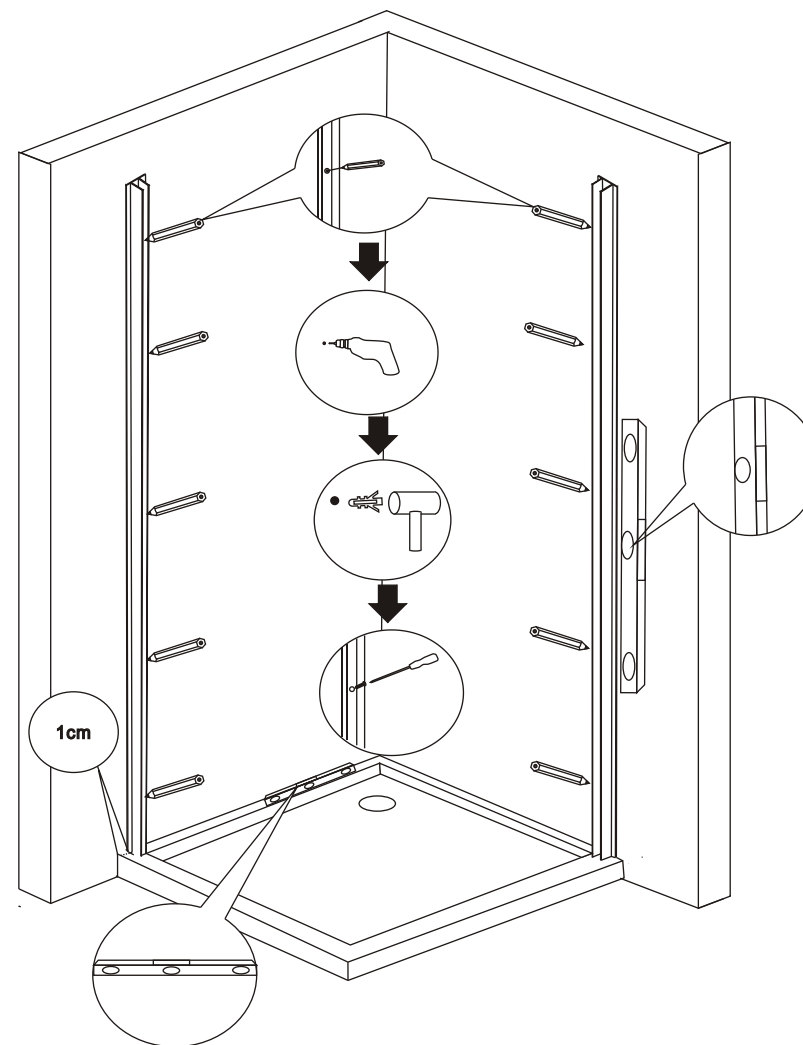
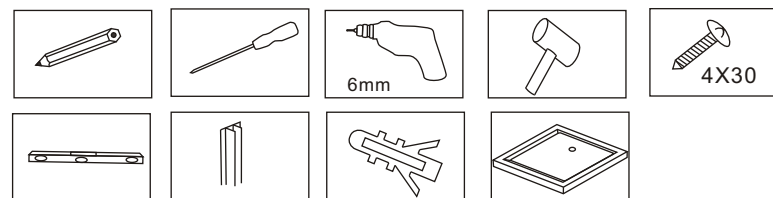

1. Insert the fixed glass into wall aluminium profile.
2. Install the magnetic gasket on the fixed glass.

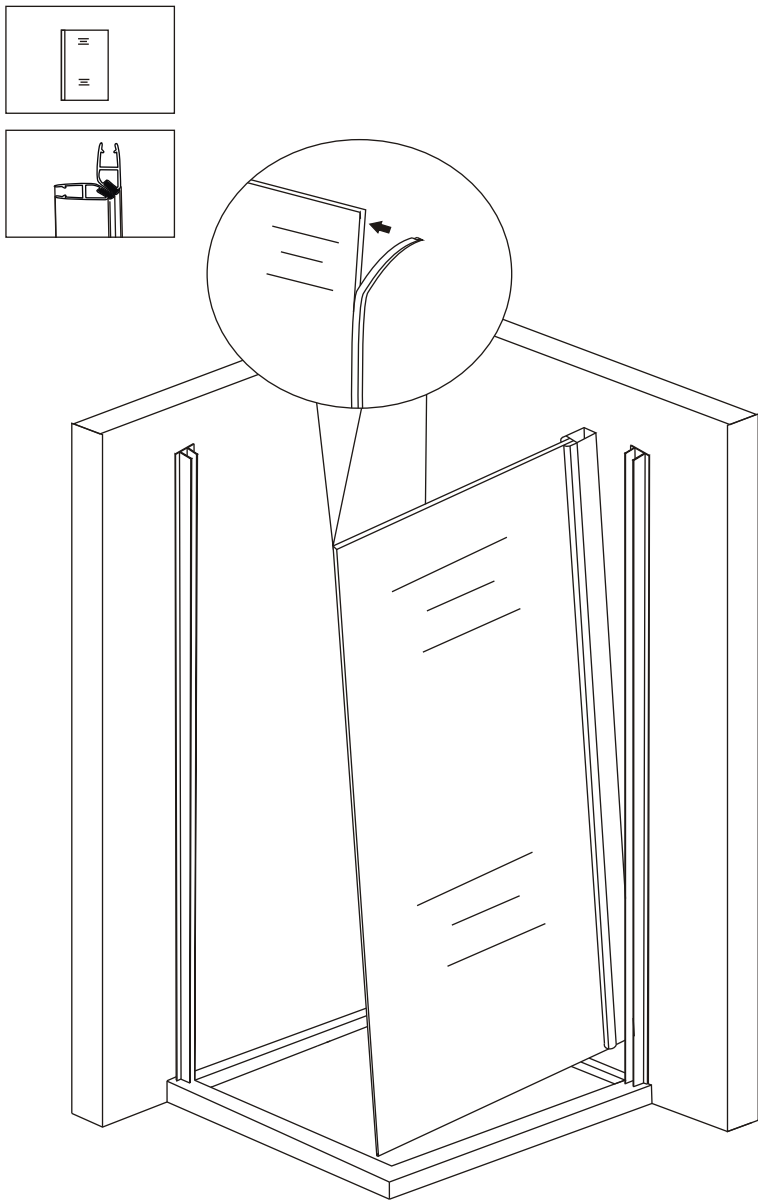

1. Insert the door into wall aluminium profile.
2. Install the magnetic gasket on the door.

