

# Montageanleitung

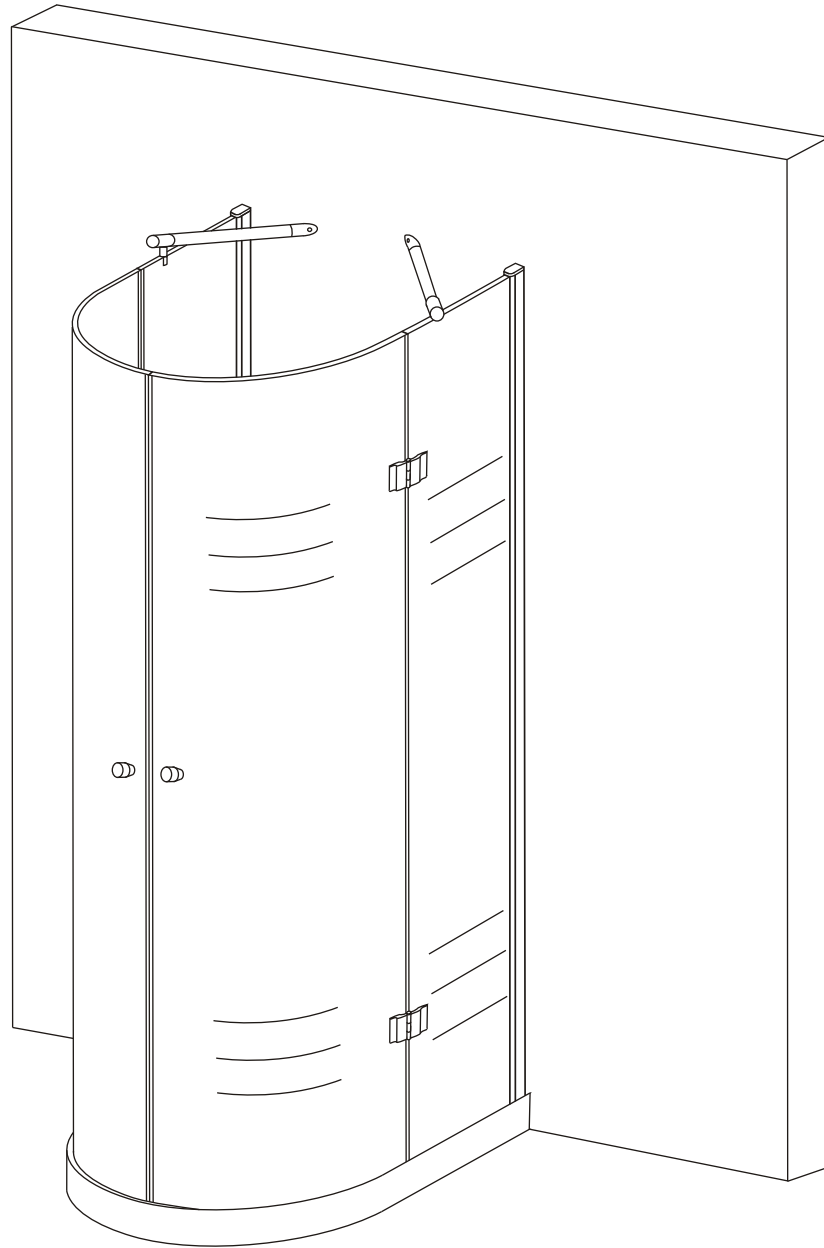

3021/3020

**RoHS** **CE** **ISO9001:2000**

# Benötigtes Werkzeug

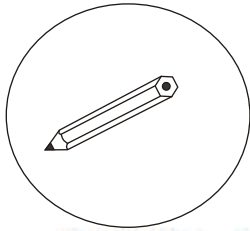

Bleistift

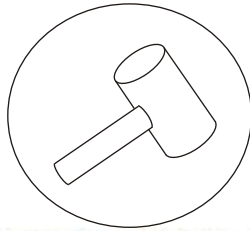

Gummi Hammer

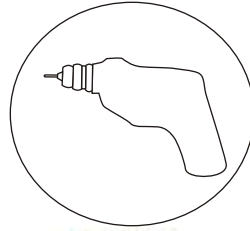

Bohrer

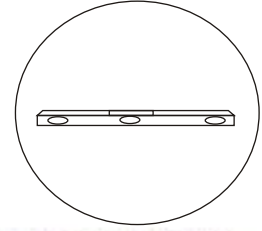

Wasserwaage

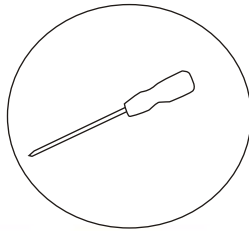

Schraubendreher

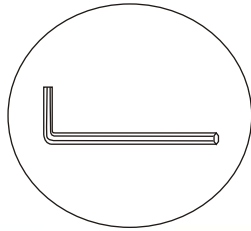

Inbusschlüssel

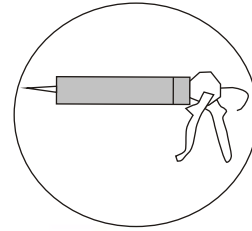

Silikon

# Teileliste

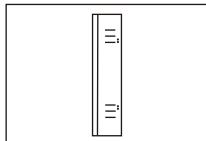

Glass

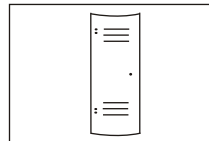

Glass

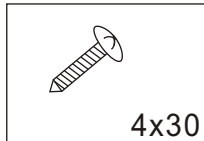

4x30

Screw

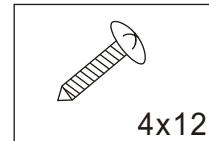

4x12

Screw

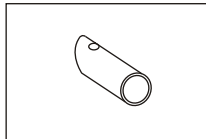

PJ-4317

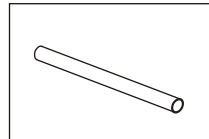

LG-2004

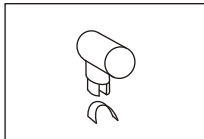

PJ-4416

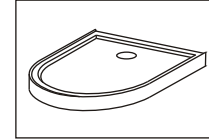

Tray

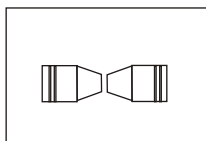

LS-1202

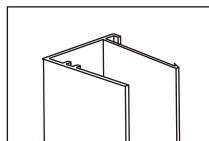

Wall profile

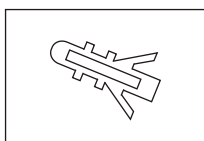

Expand tube

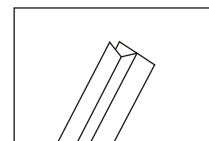

CT-8DST180

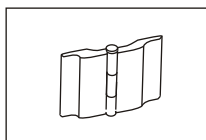

HY-3304

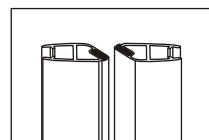

CT-8BMX90

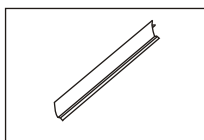

Side cover

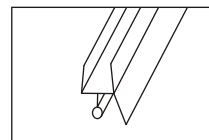

CT-8DSTQ

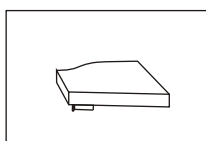

PJ-4514/  
PJ-4515

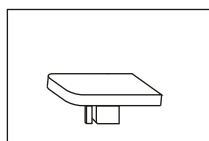

PJ-4509

1. Platzieren Sie die Duschtasse, nehmen Sie eine Wasserwaage
2. Stellen Sie die Wandprofile vertikal auf und markieren sie die Bohrlöcher (Achten Sie auf den Montagehinweis)
3. Bohren Sie an der Markierung und setzen die Dübel
4. Schrauben Sie die Wandprofile an die Wand

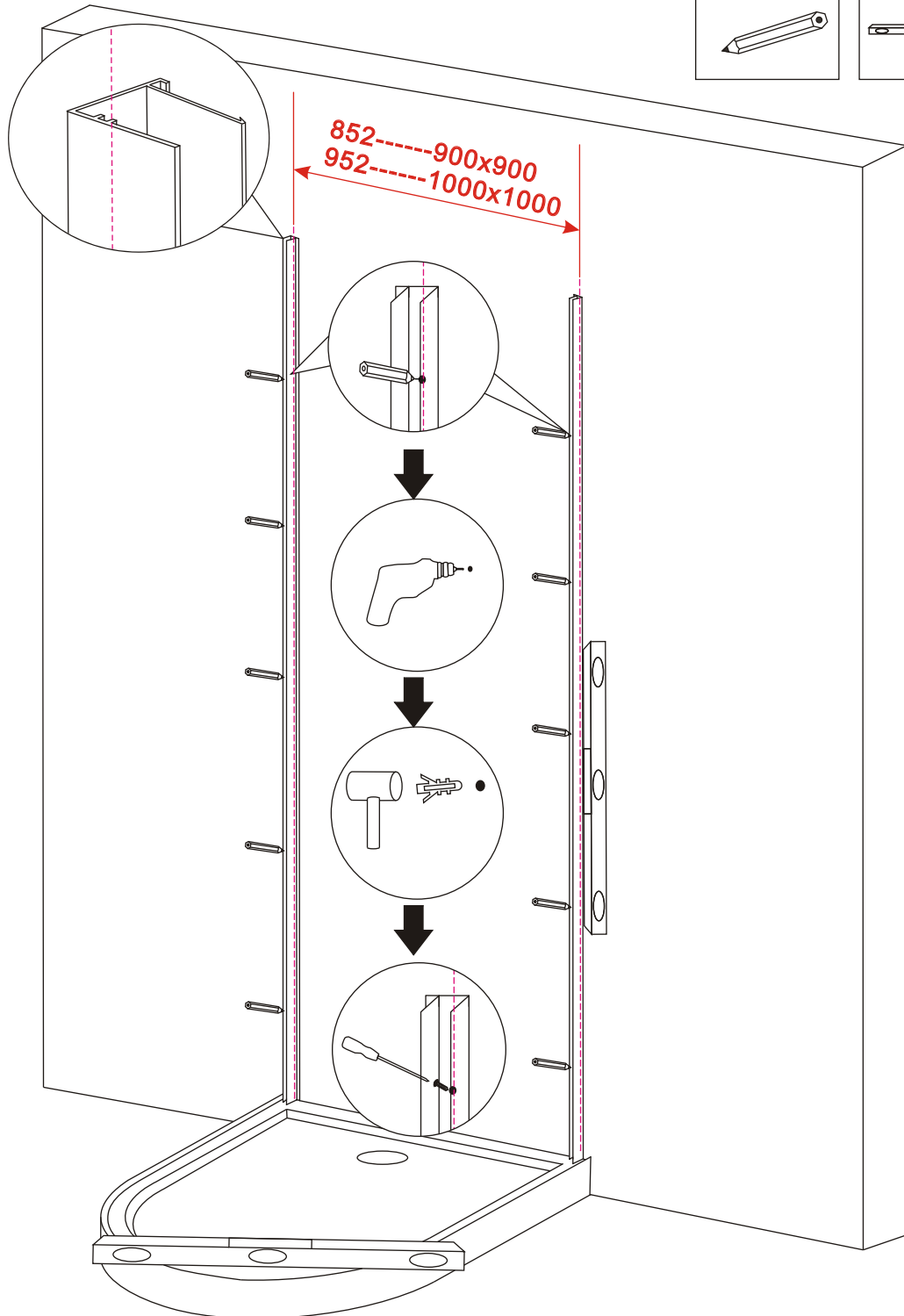
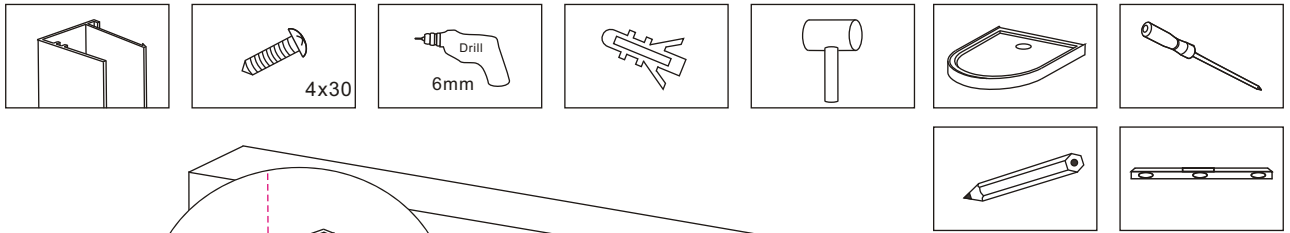

Bereiten Sie die Tür-Gläser vor, bringen Sie die Dichtleisten wie abgebildet an

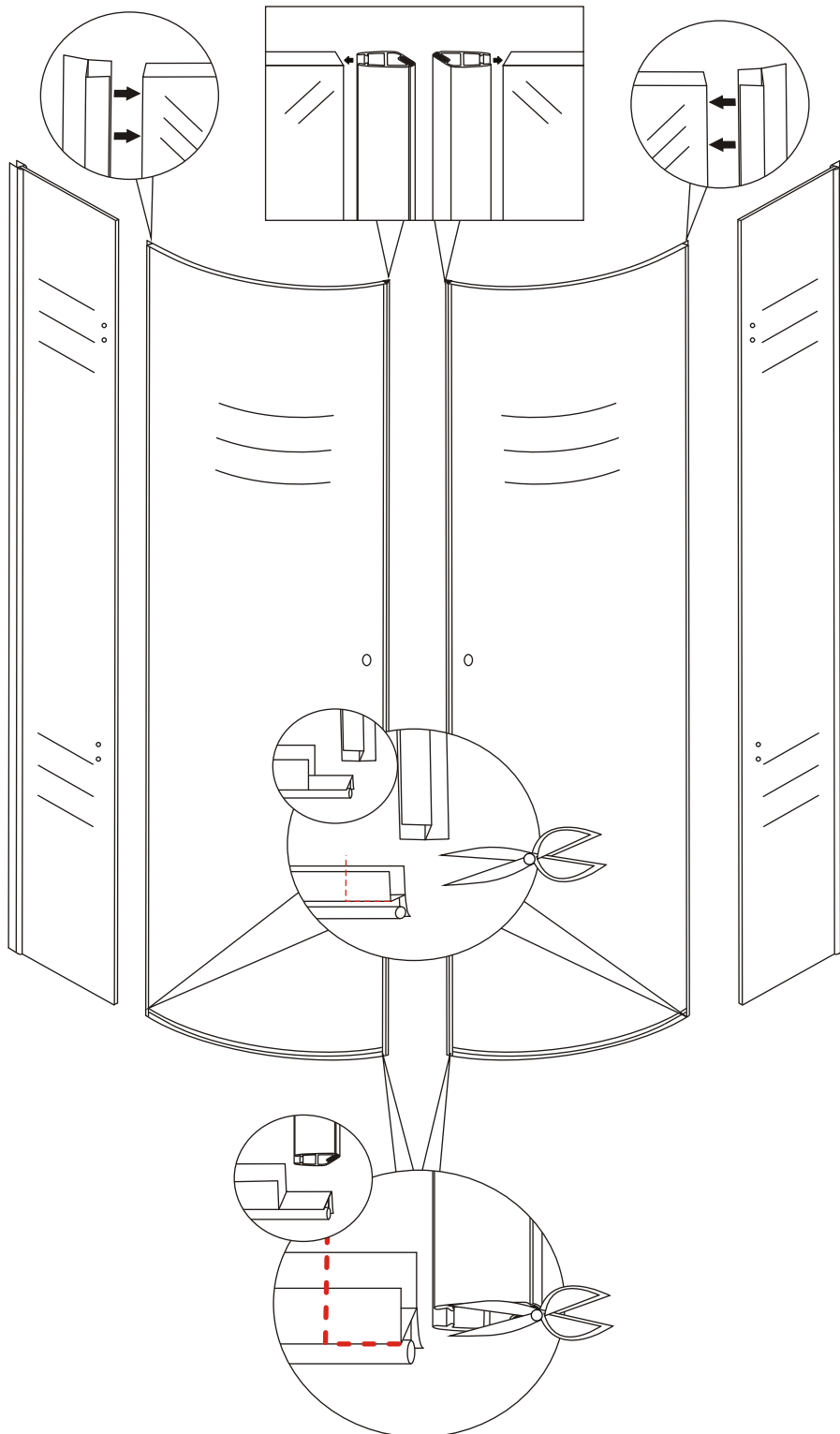
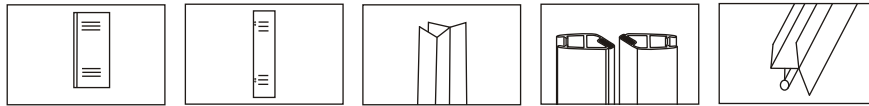

Um die bestmögliche Dichtheit zu gewährleisten, lassen Sie die unteren Tür-Dichtungen überstehen, schneiden Sie jeweils einen 90 Grad Winkel rein, die vertikalen Dichtleisten werden von oben auf „stoß“ gesenkt

Führen Sie vorsichtig beiden feststehenden Seiten-Elemente in die Wandprofile, lassen Sie den Kantenschutz am Glas

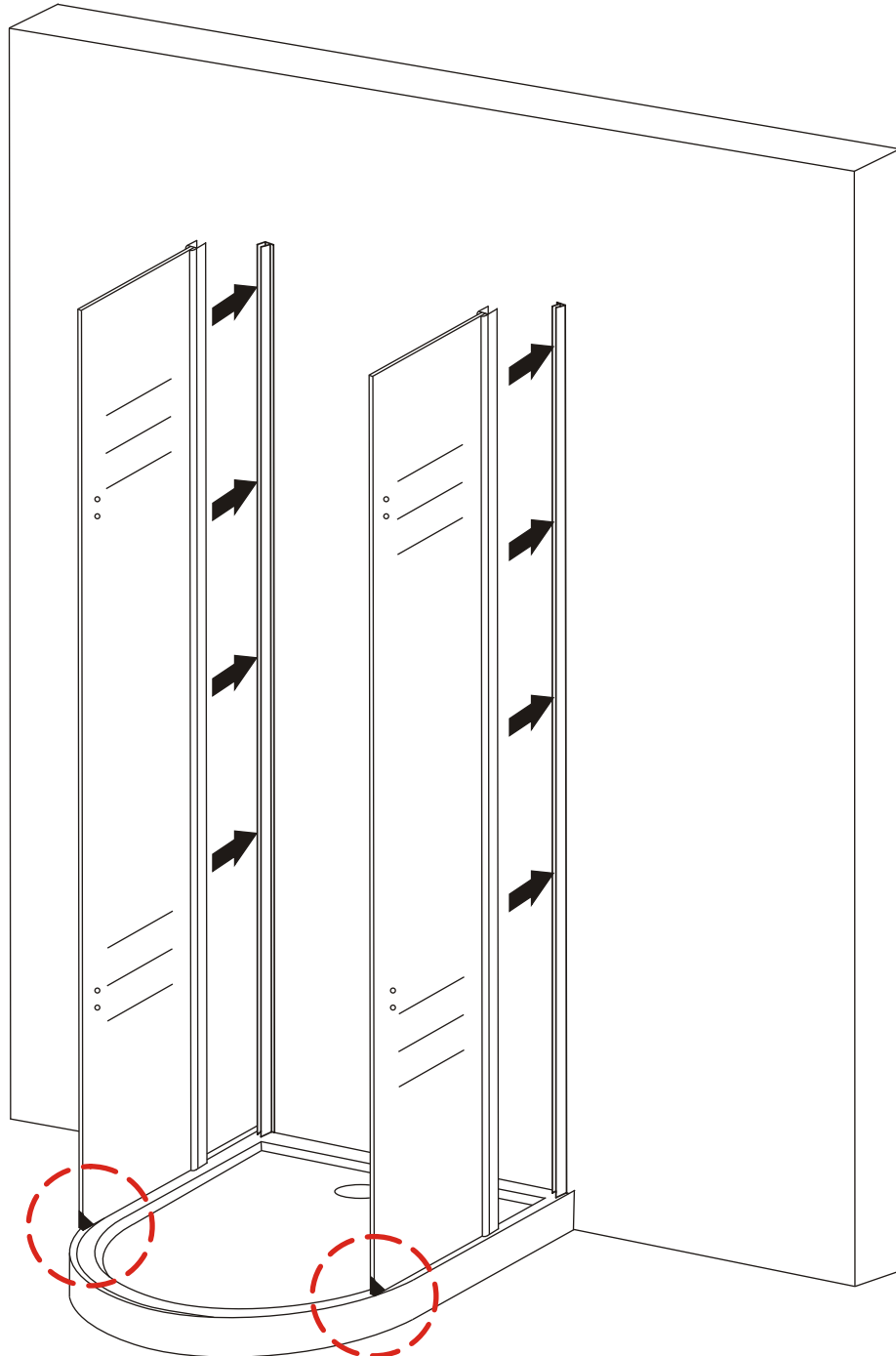

Schrauben Sie die Scharniere an den feststehenden Elementen

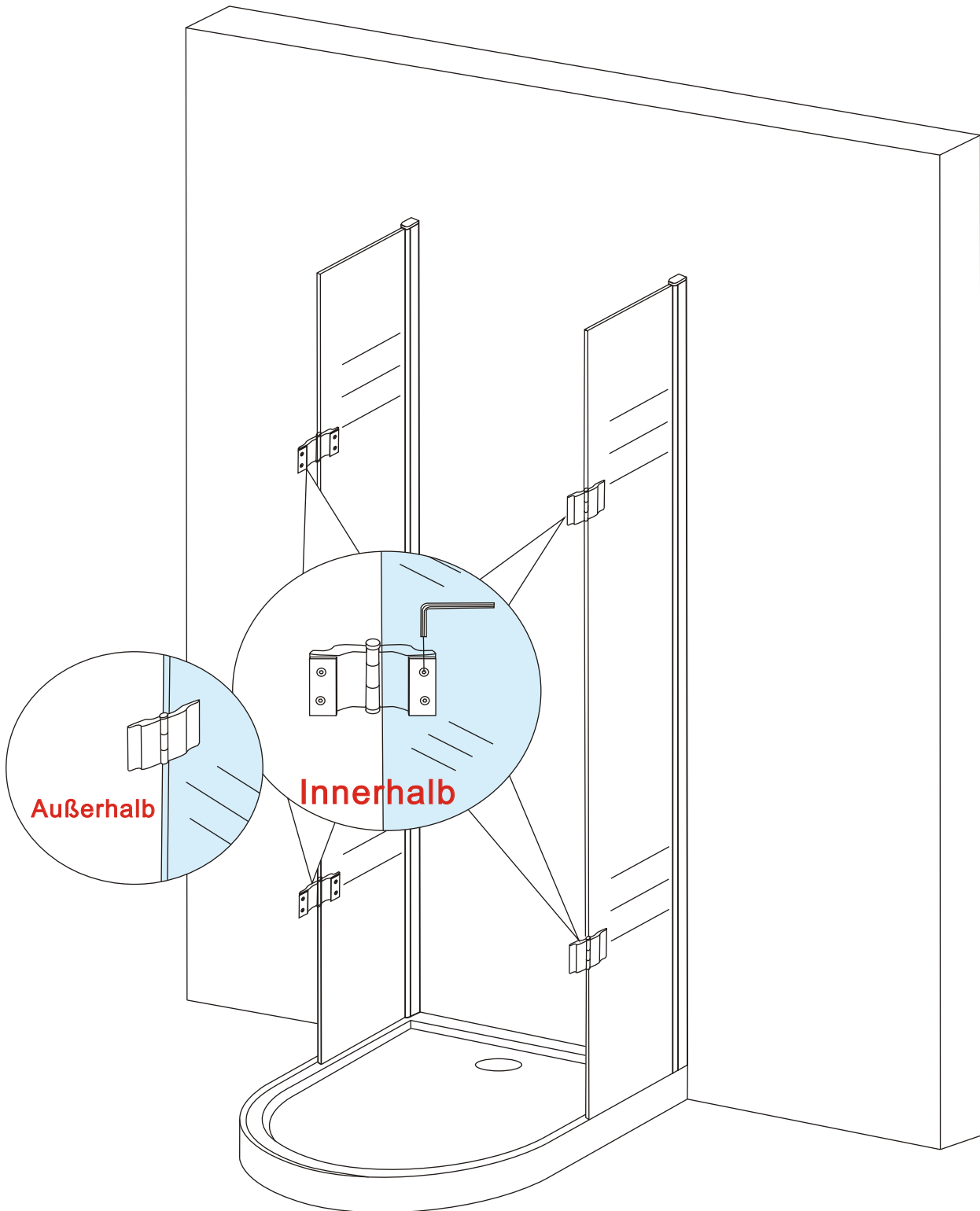
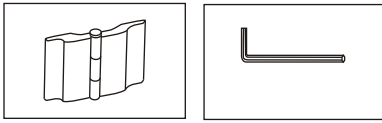

Verschrauben Sie die Tür-Gläser mit den Scharnieren

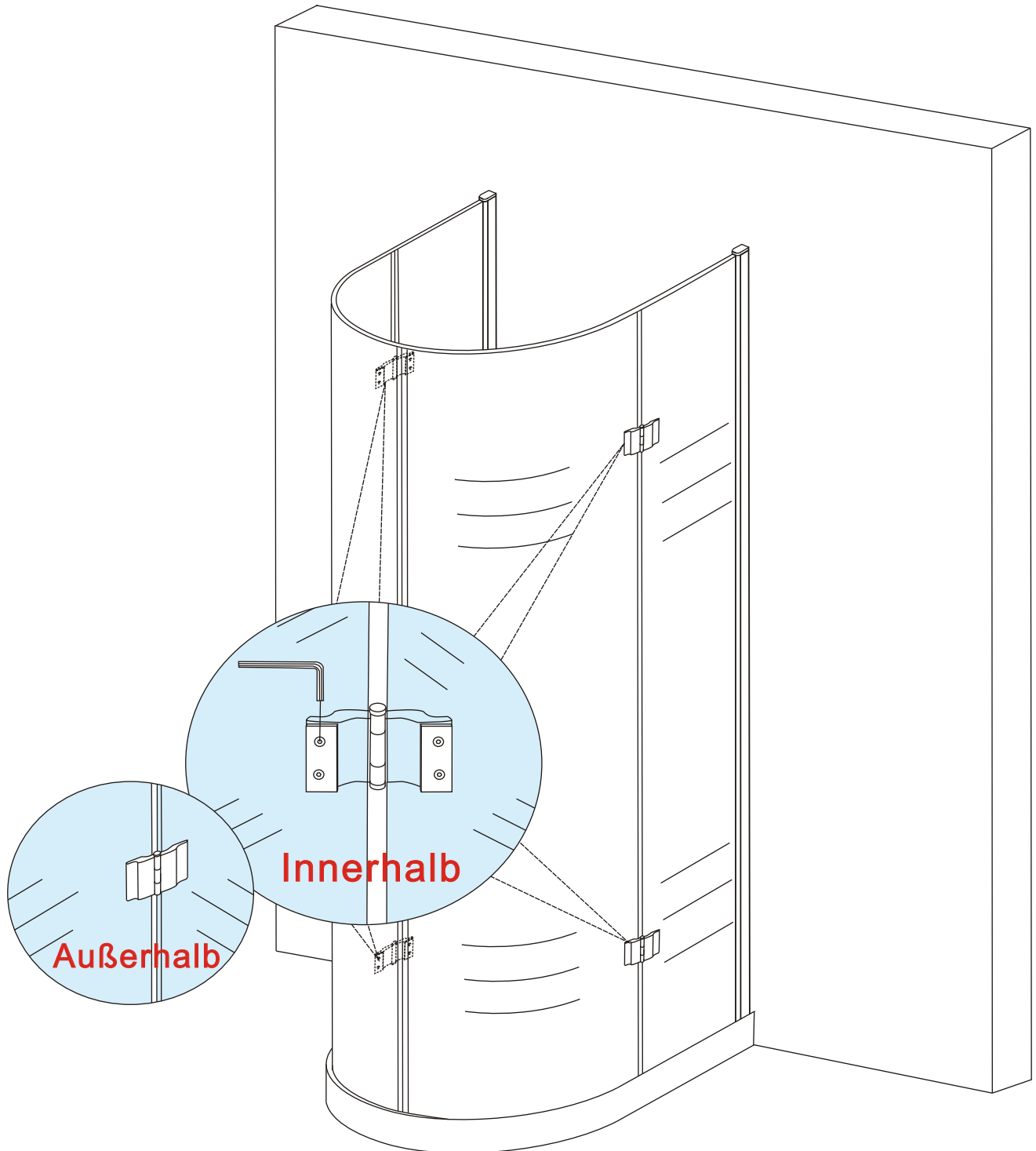
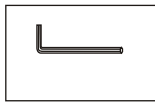

Installieren Sie die Stabilisierungsstangen an den feststehenden Elementen entsprechend dem nachfolgenden Bild

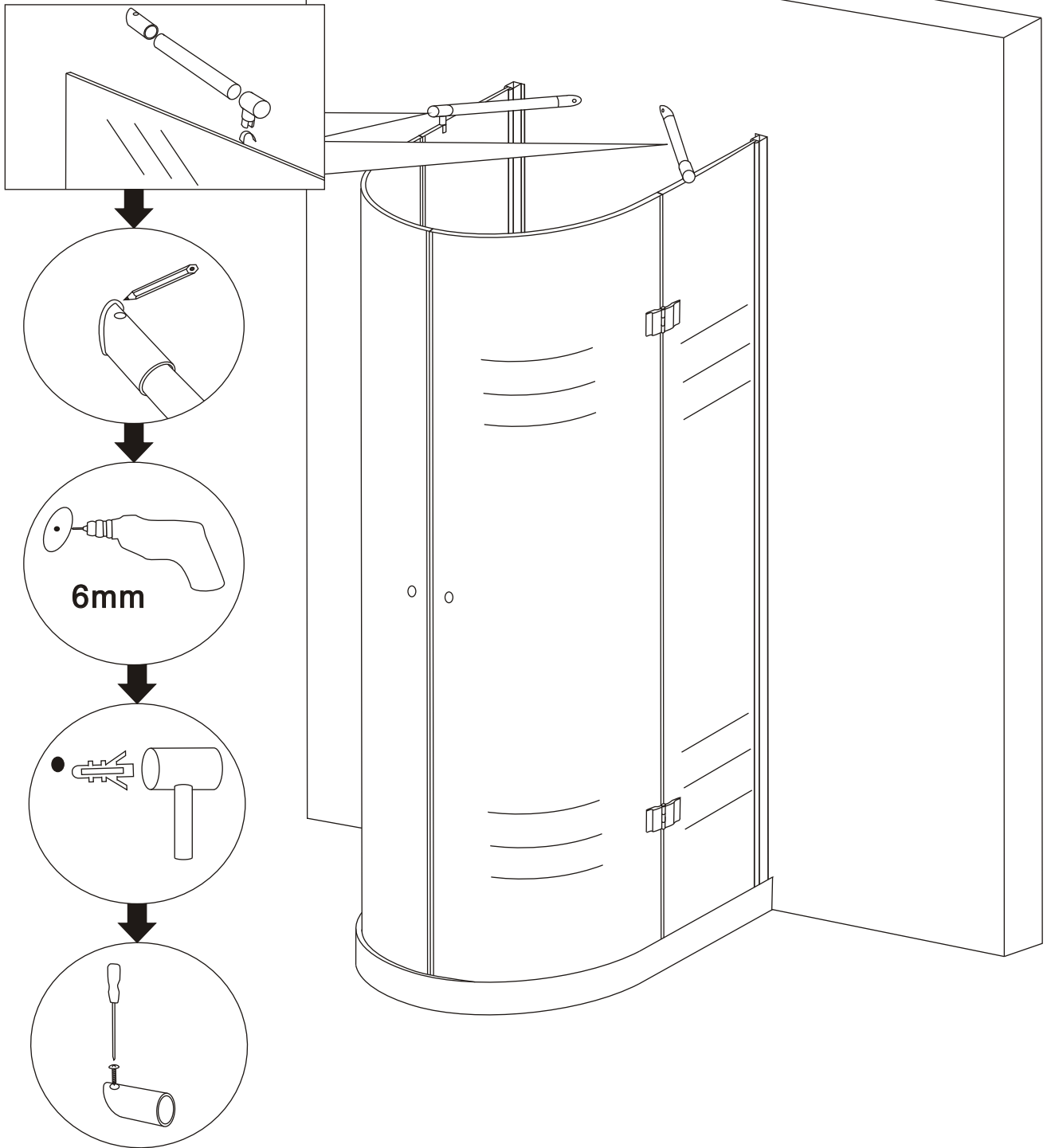
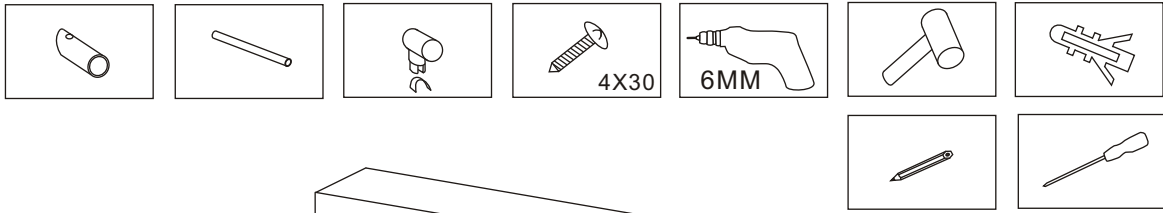



1. Bohren Sie an den vorgesehenen Stellen durch die Wandprofile und fixieren Sie die feststehenden Elemente mittels der beigefügten Schrauben
2. Bringen Sie anschließend die obere Profilabdeckung sowie die Abdeckleiste zwecks Verdeckung der Verschraubung an, diese ist ein zu klinken

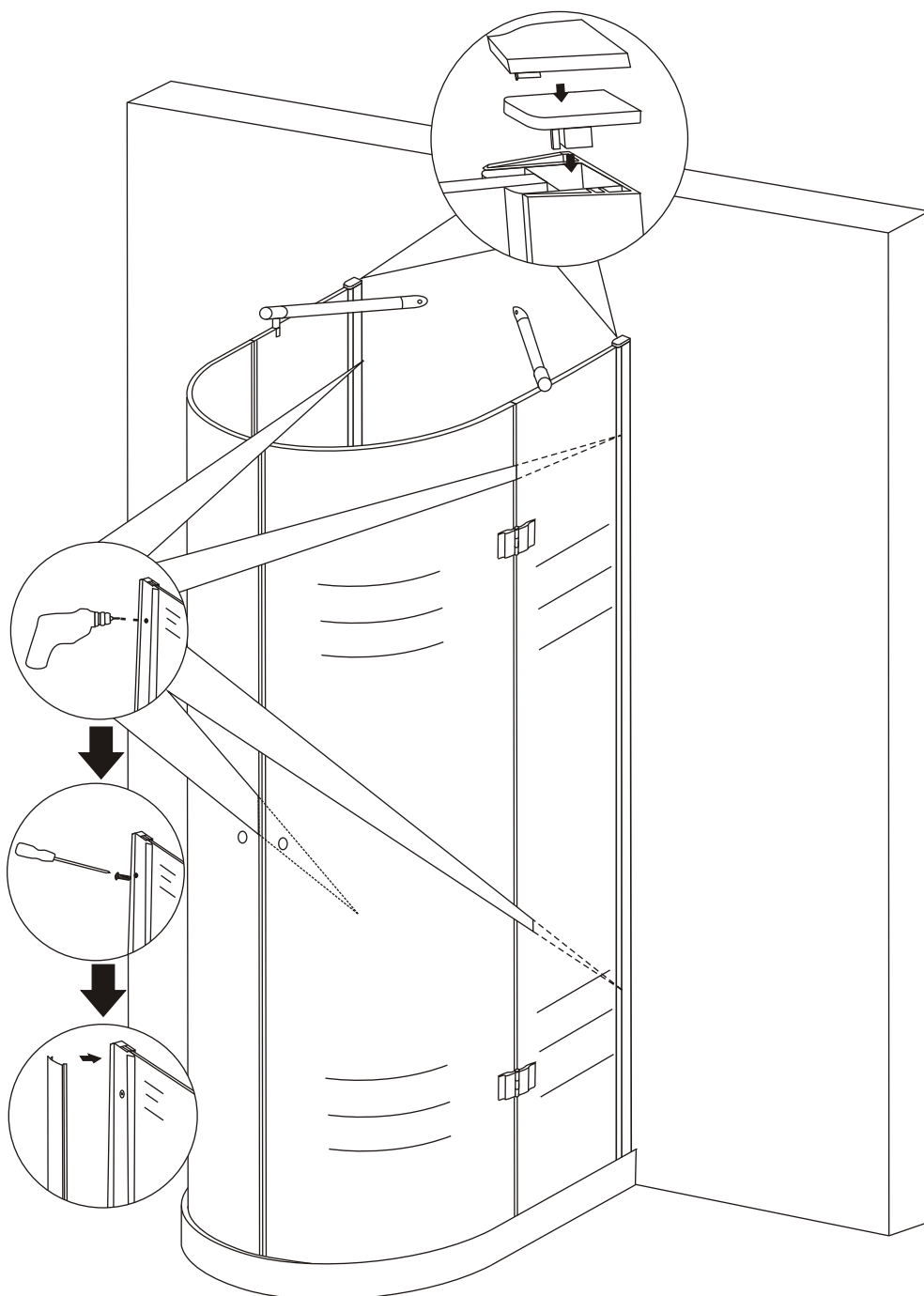
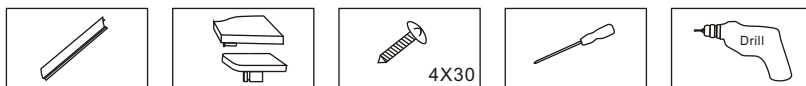

Verschrauben Sie die Türgriffe und versiegeln Sie die feststehenden Elemente von innen & außen mittels Silikon

