

Montageanleitung

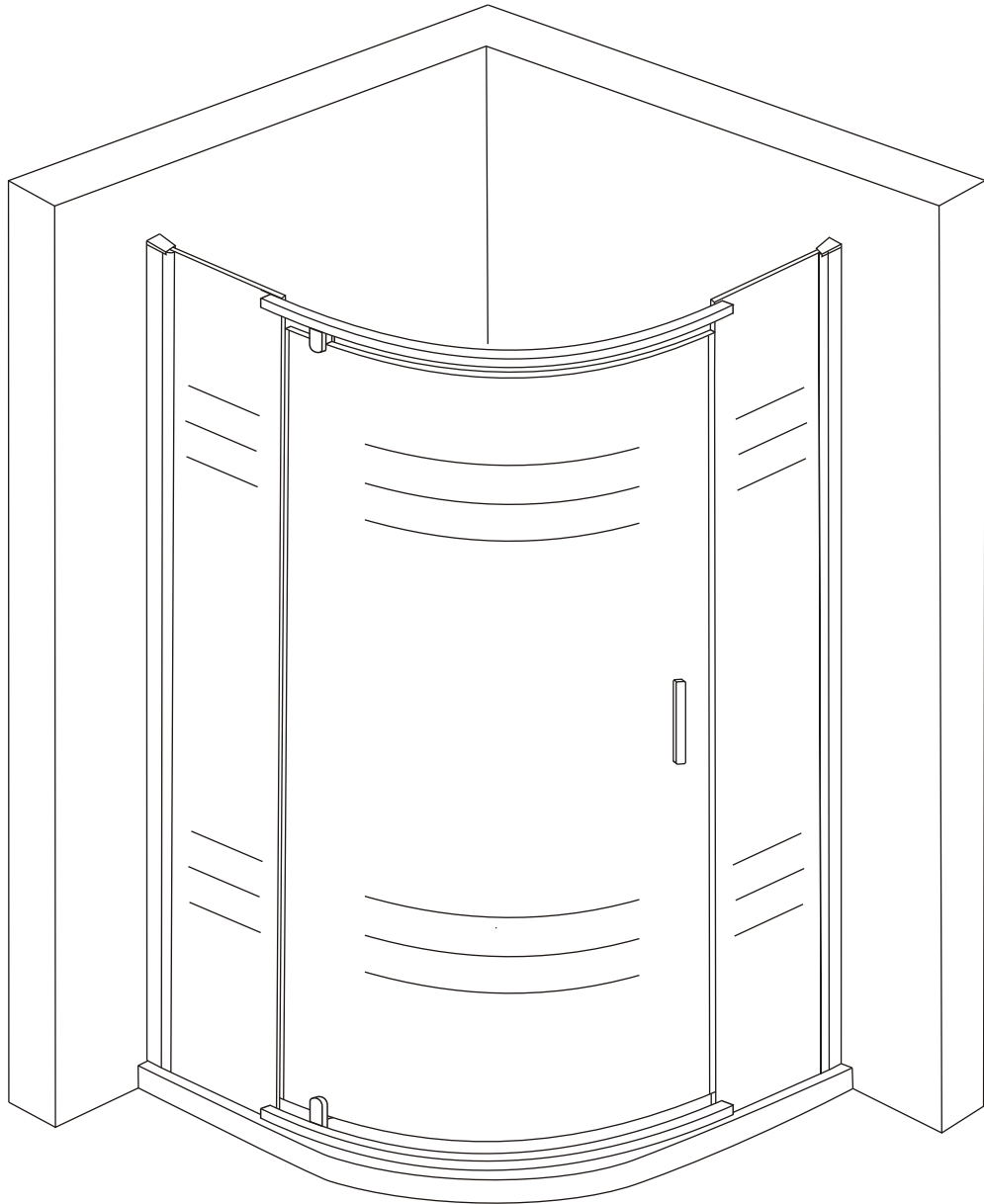

3174/3175/3176

RoHS **CE** **ISO9001:2000**

Benötigtes Werkzeug

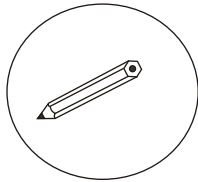

Bleistift

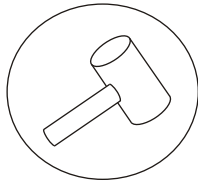

Gummi Hammer

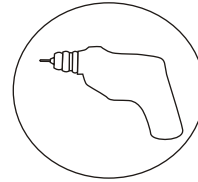

Bohrer

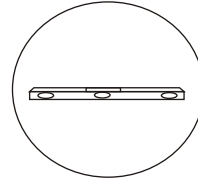

Wasserwaage

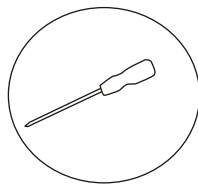

Schraubendreher

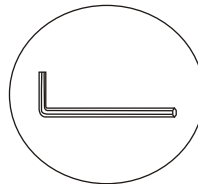

Inbusschlüssel

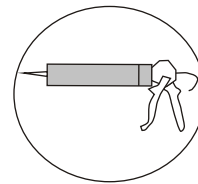

Silikon

Teileliste

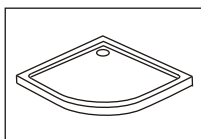

Tray

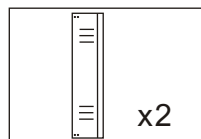

Glass

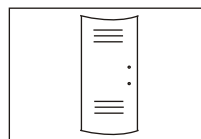

Glass

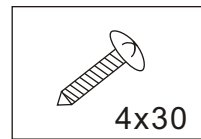

Screw

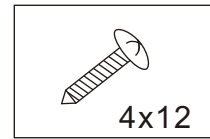

Screw

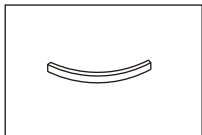

Rail bar

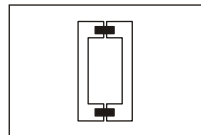

LS-1105

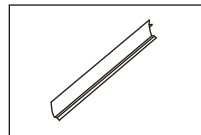

Side cover

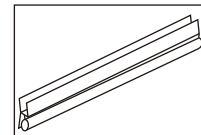

CT-8DSTQ

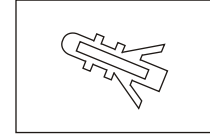

Expand tube

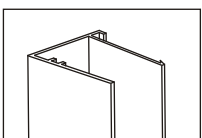

Wall profile

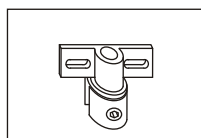

HY-3306

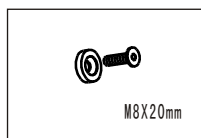

PJ-4408

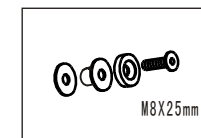

PJ-4408

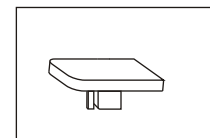

PJ-4509

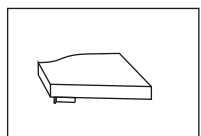

PJ-4514/
PJ-4515

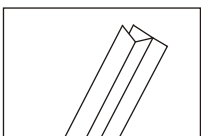

CT-8DST180

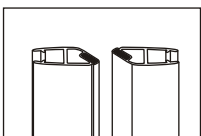

CT-8BMX90

Platzieren Sie die Duschtasse, nehmen Sie eine Wasserwaage zur Hand
Zeichnen Sie die Montagelinie zwecks Installation der Wandprofile an

Maße	Schenkelmaß A	Schenkelmaß B
900X900	865	865
800X800	765	765
1000X1000	965	965

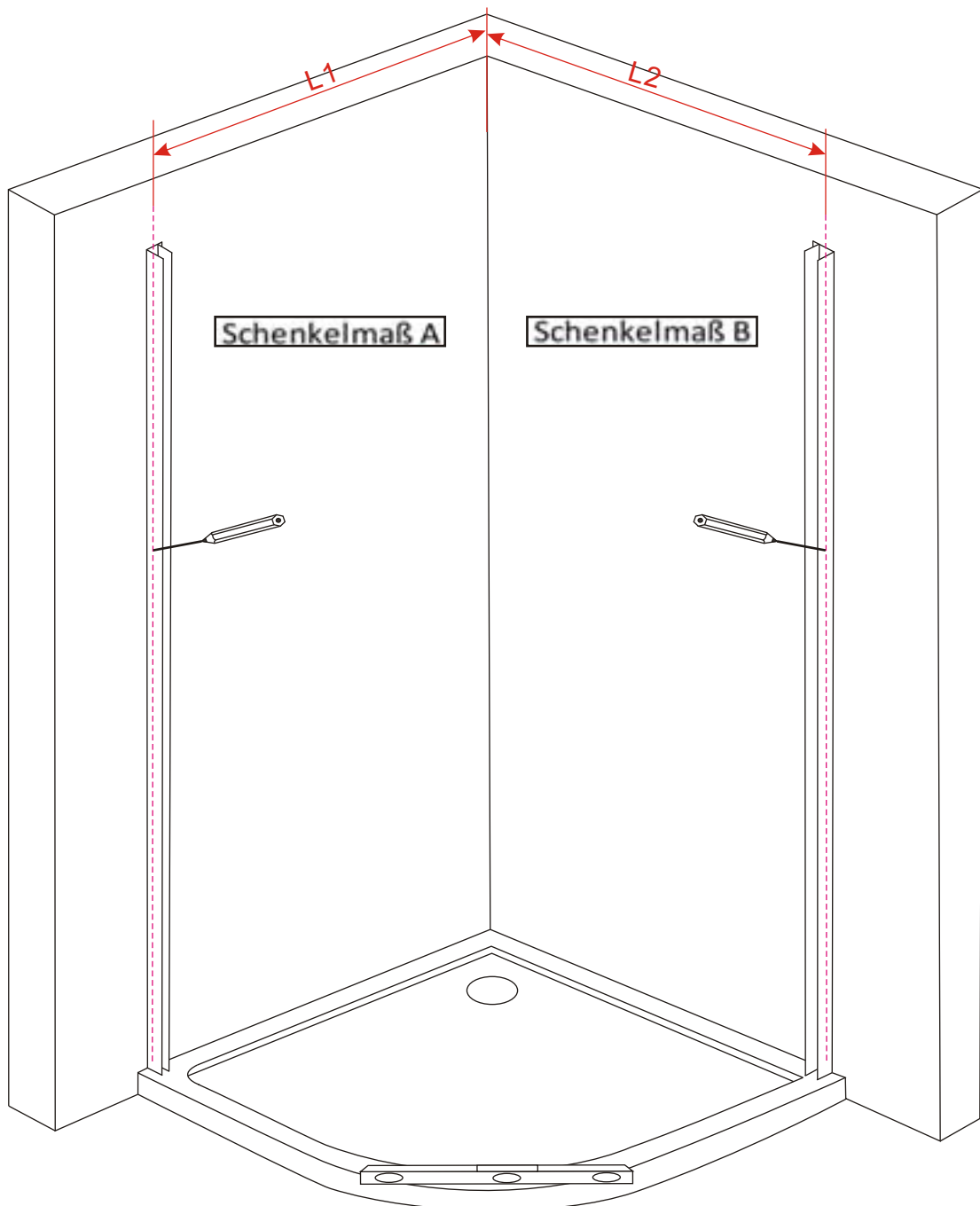

1. Markieren Sie die Bohrlöcher durch anhalten der Wandprofile (die Vorbohrungen im Wandprofil müssen sich auf der Montagelinie befinden)
2. Bohren Sie an der Markierung und setzen Sie die Dübel in die Wand
3. Schrauben Sie das Wandprofil an die Wand

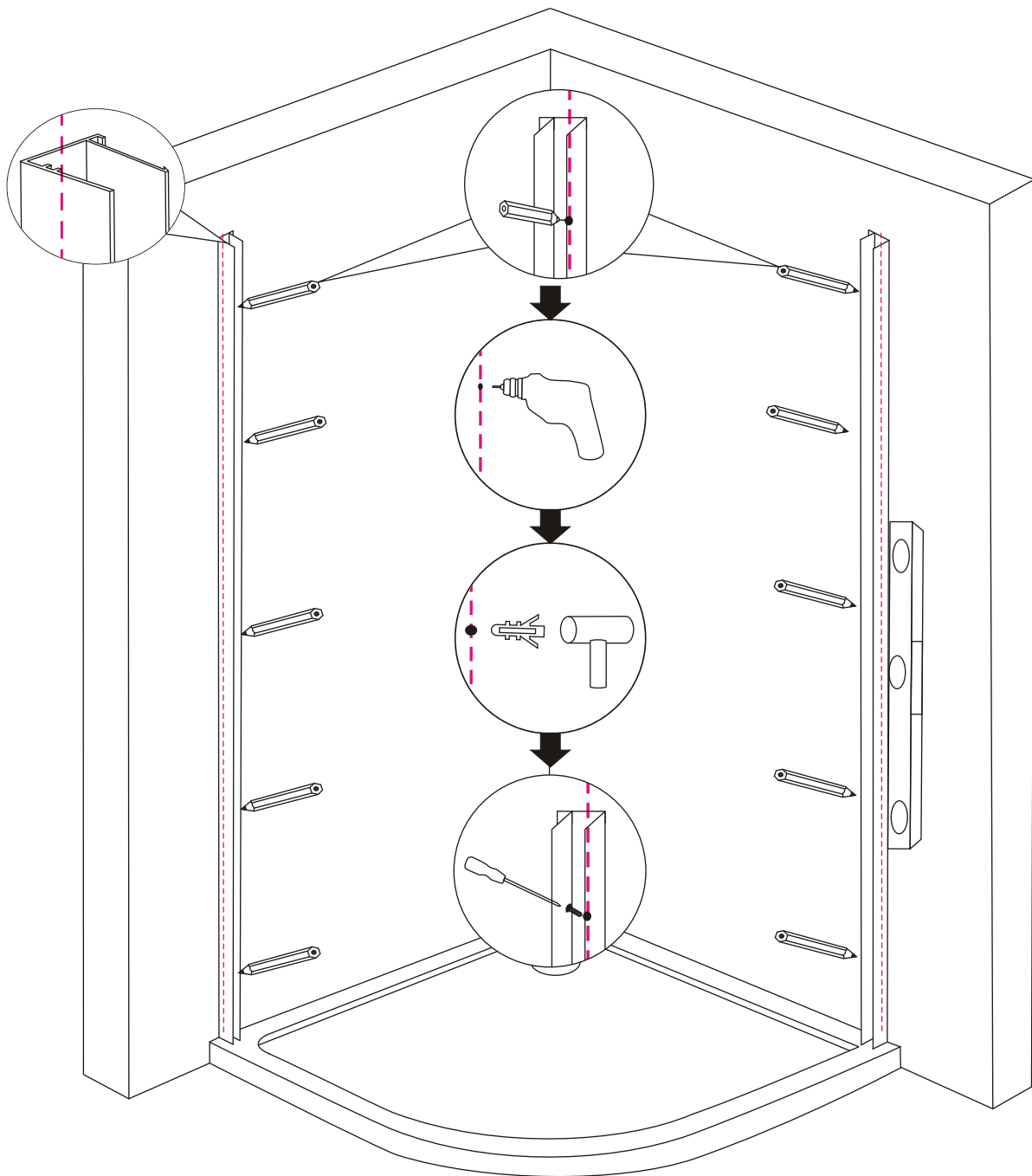
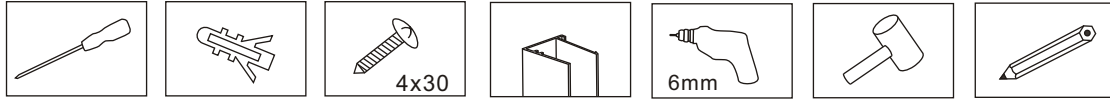

Bringen Sie die senkrechten Dichtleisten sowie die untere Türdichtung gemäß der Abbildung an und lassen Sie die Türdichtung überstehen. Schneiden Sie 90 Grad Winkel in die Dichtung, die vertikalen Dichtleisten werden von oben auf „stoß“ gesenkt. Die Magnetleisten sind am Einstieg, zwischen Tür- & Seitenelement anzubringen

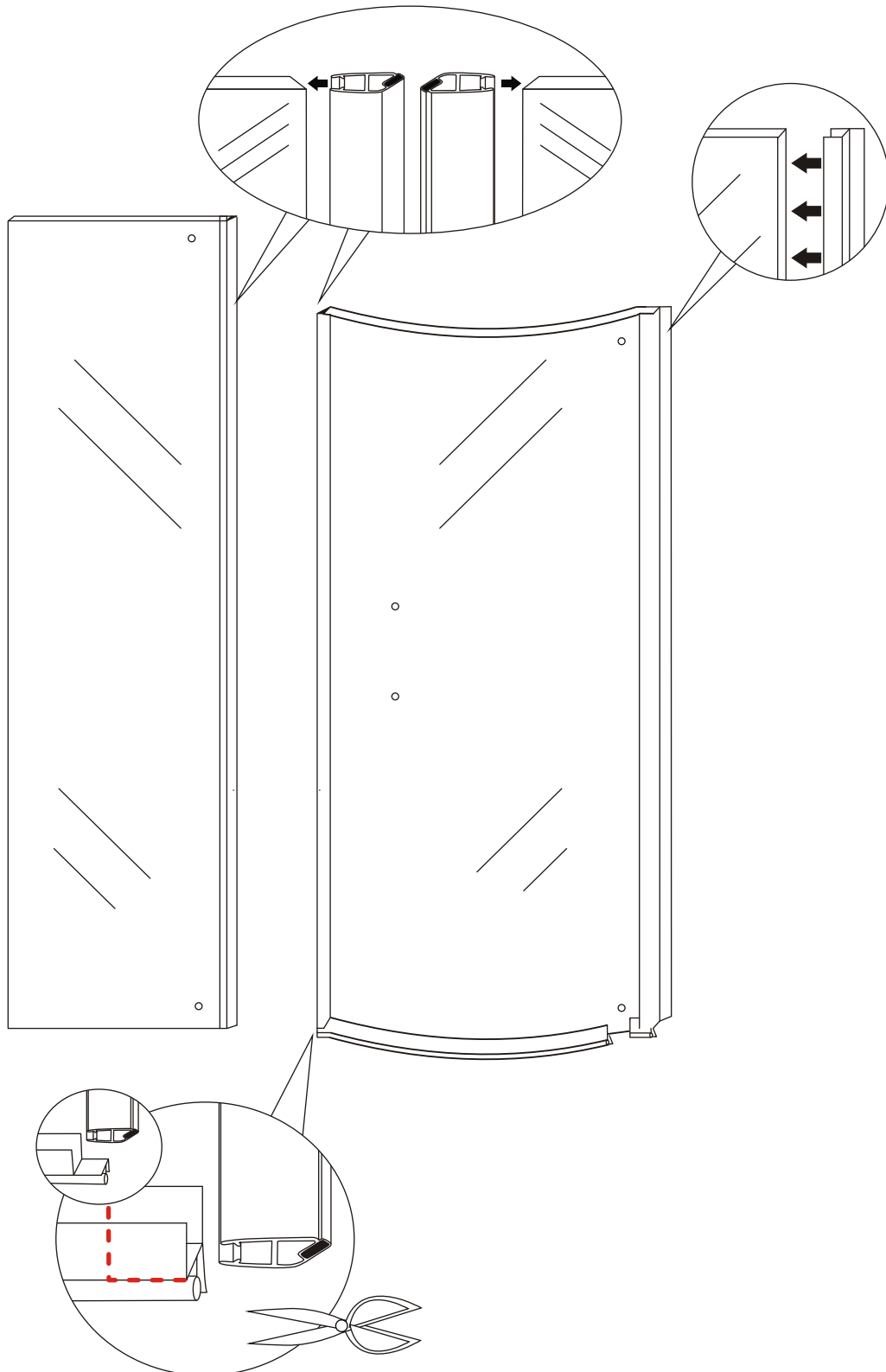
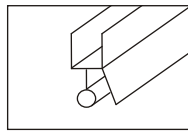
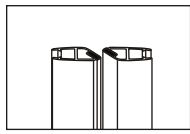
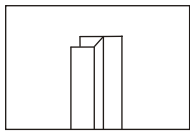

Führen Sie beide feststehenden Seitenelemente in die Wandprofile

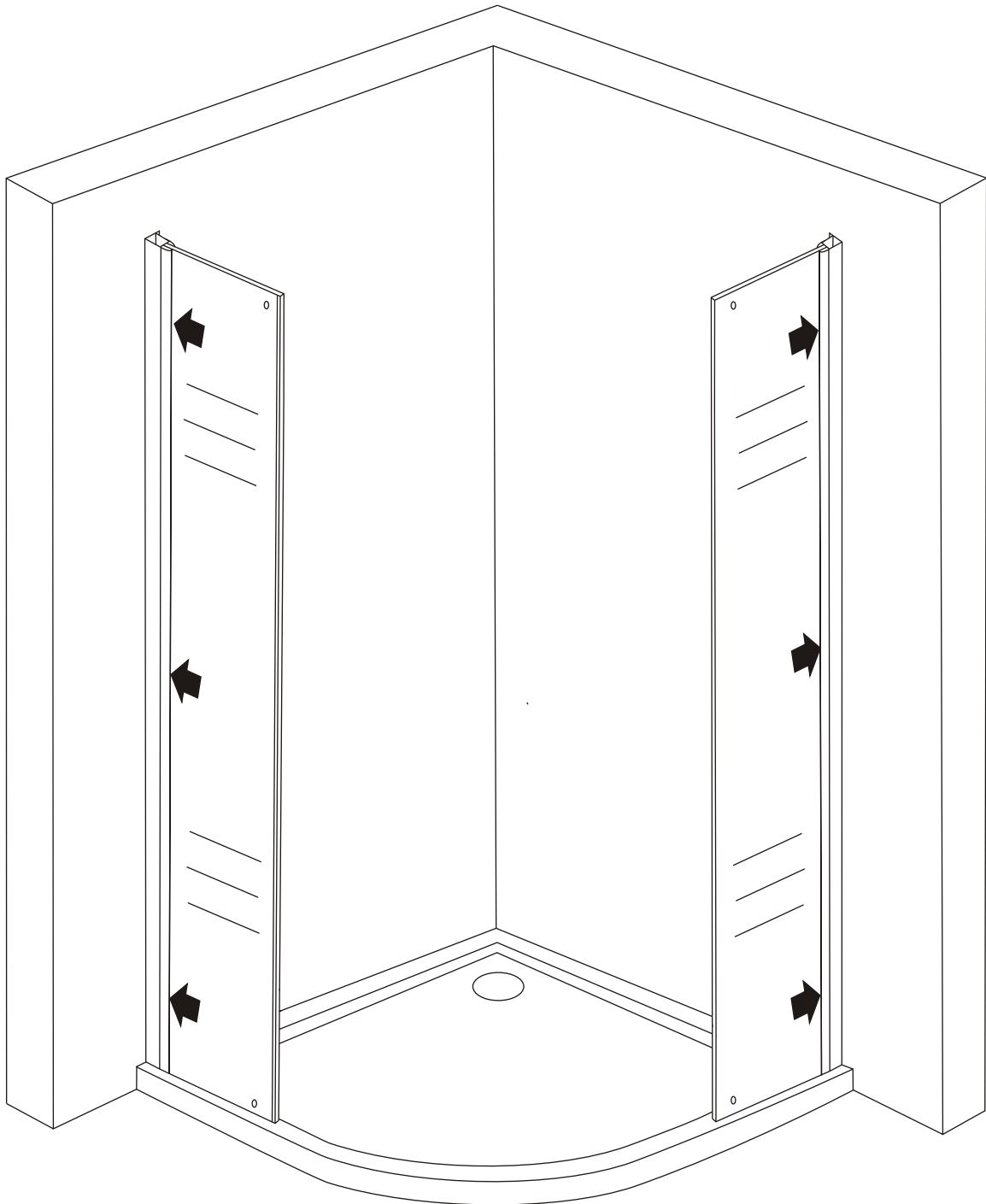
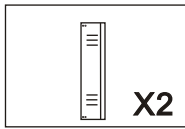

Installieren Sie den oberen und unteren Bügel, in der später die Tür ein-
gehangen wird, entsprechend der Abbildung

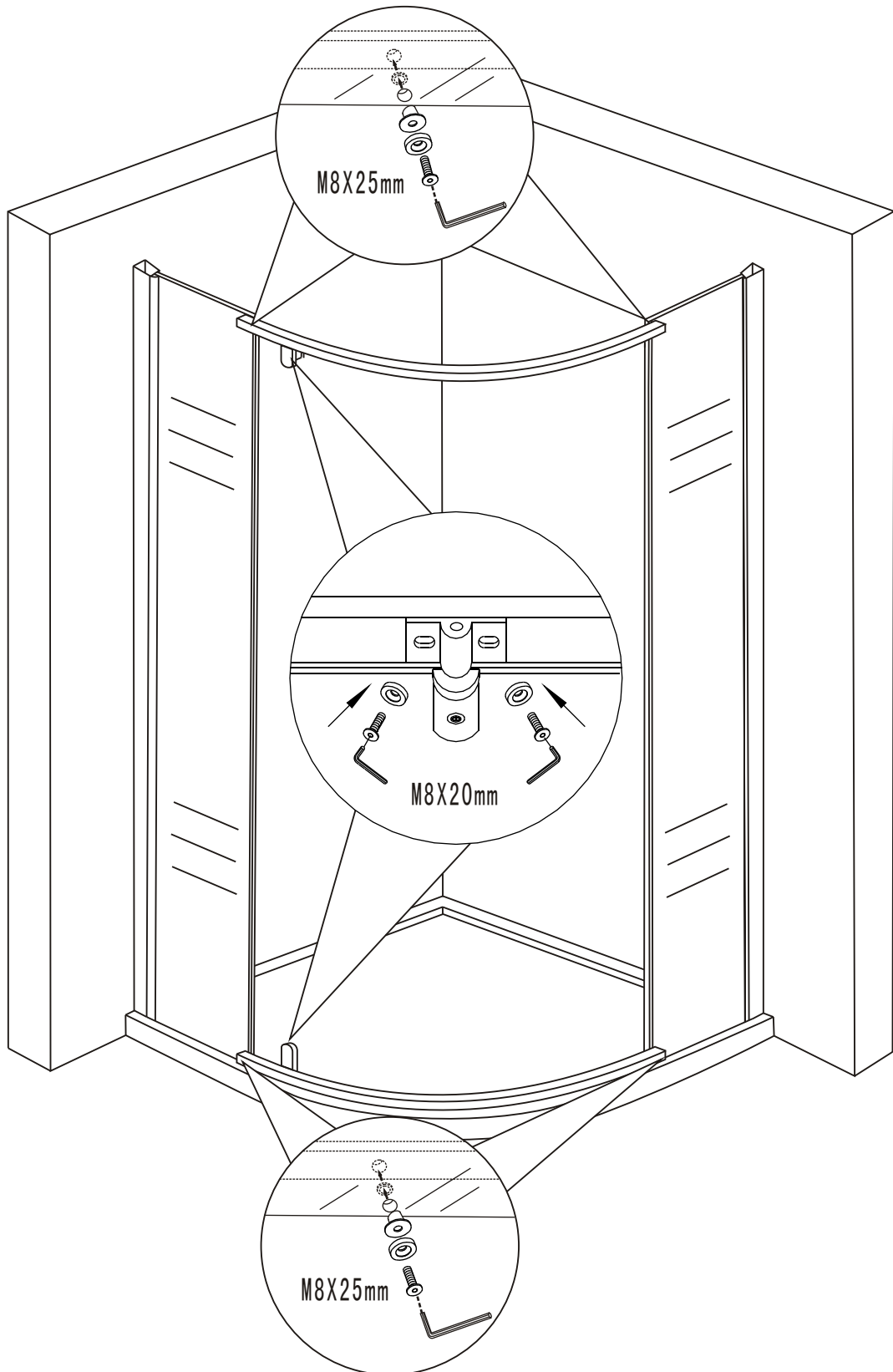
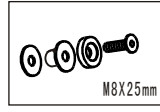
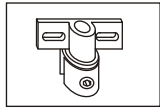
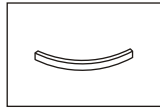
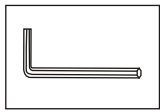

1. Hängen Sie die Tür ein, fixieren Sie diese entsprechend der Abbildung
2. Richten Sie nun die beiden Wand-Elemente aus
3. Bohren Sie anschließend wie abgebildet an den vorgesehenen Stellen durch die Wandprofile und fixieren Sie die Wand-Elemente mittels der beigefügten Schrauben
4. Bringen Sie die Abdeckleisten zwecks Verdeckung der Verschraubung sowie die oberen Profilabdeckungen an

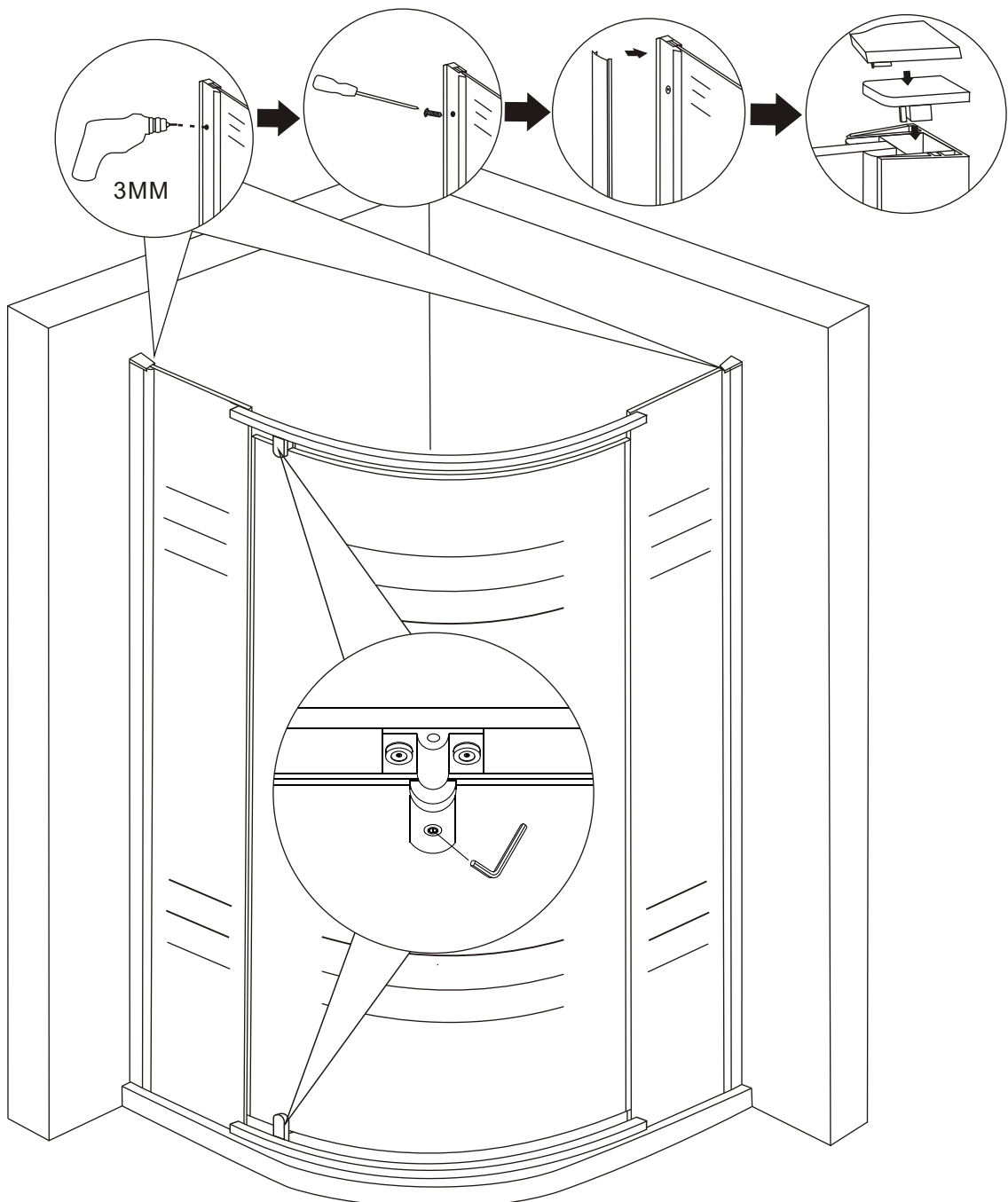
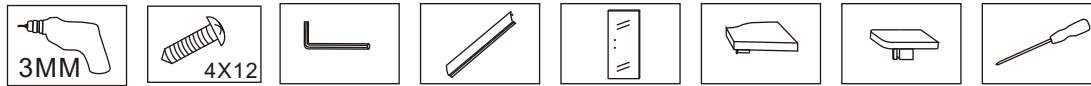

Verschrauben Sie den Türgriff und versiegeln Sie die Wand-Elemente sowie den unteren Bügel von innen & außen mittels Silikon, ggf. können auch die Wandprofile abgespritzt werden

