

Montageanleitung: Fünfeck-Dusche

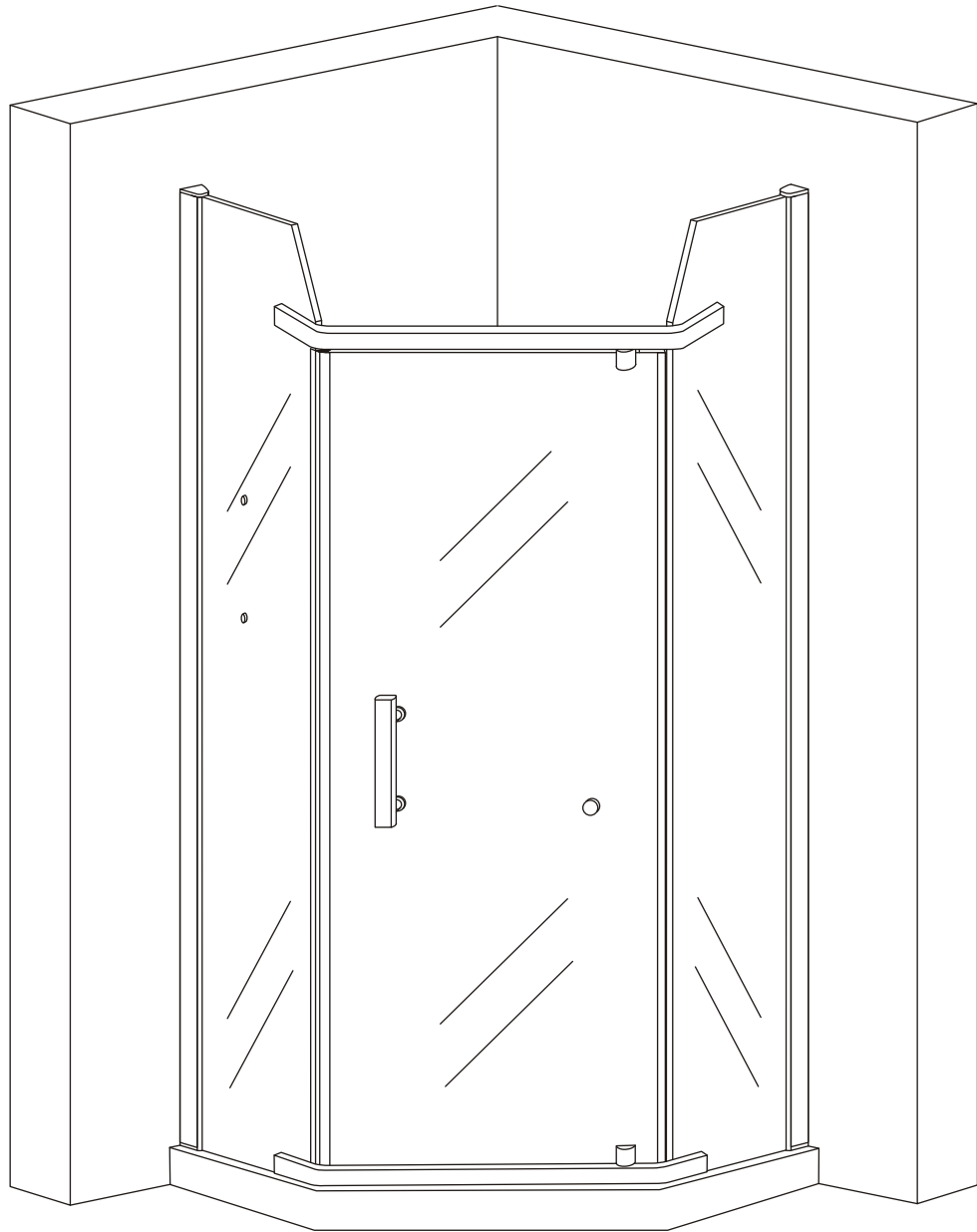

3071/3070

RoHS **CE** **ISO9001:2000**

Benötigtes Werkzeug

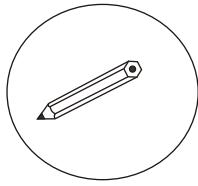

Bleistift

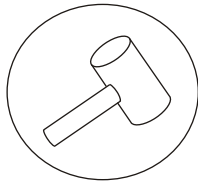

Gummi Hammer

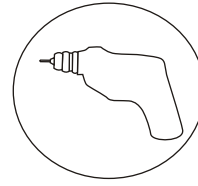

Bohrer

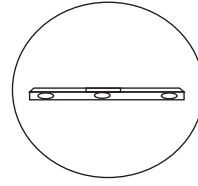

Wasserwaage

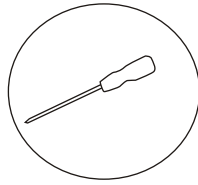

Schraubendreher

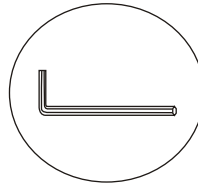

Inbusschlüssel

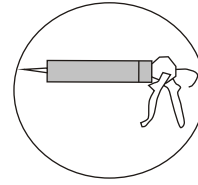

Silikon

Teileliste

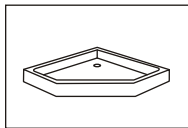

Tray

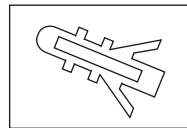

Expand tube

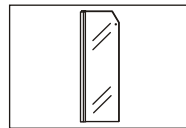

Glass

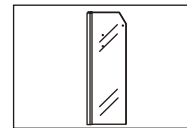

Glass

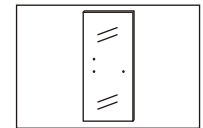

Glass

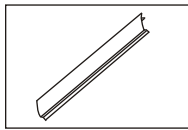

Side cover

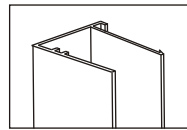

Wall profile

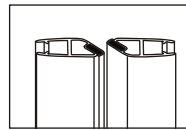

CT-8BMX90

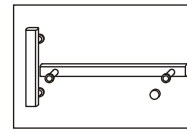

LS-1003

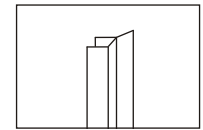

CT-8DST90-12

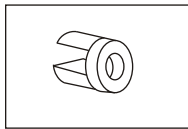

PJ-4109

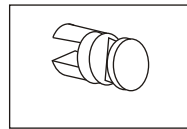

PJ-4110

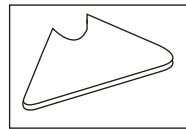

Glass shelf

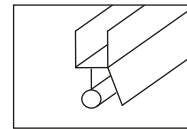

CT-8DSTQ

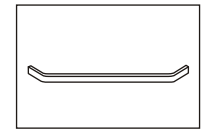

Rail bar

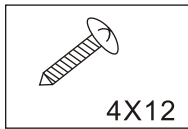

4X12

Screw

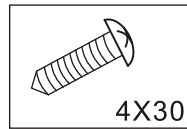

4X30

Screw

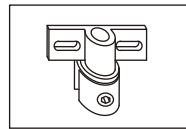

HY-3306

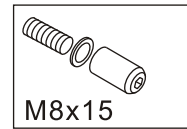

M8x15

PJ-4008

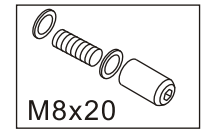

M8x20

PJ-4007

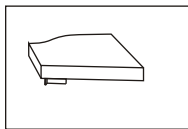

PJ-4514/
PJ-4515

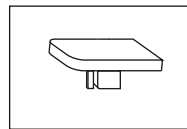

PJ-4509

Montagehinweis „Eck-Dusche“

Maße	Schenkelmaß A	Schenkelmaß B
900X900	870	870
800X800	770	770

Platzieren Sie die Duschtasse, nehmen Sie eine Wasserwaage zur Hand

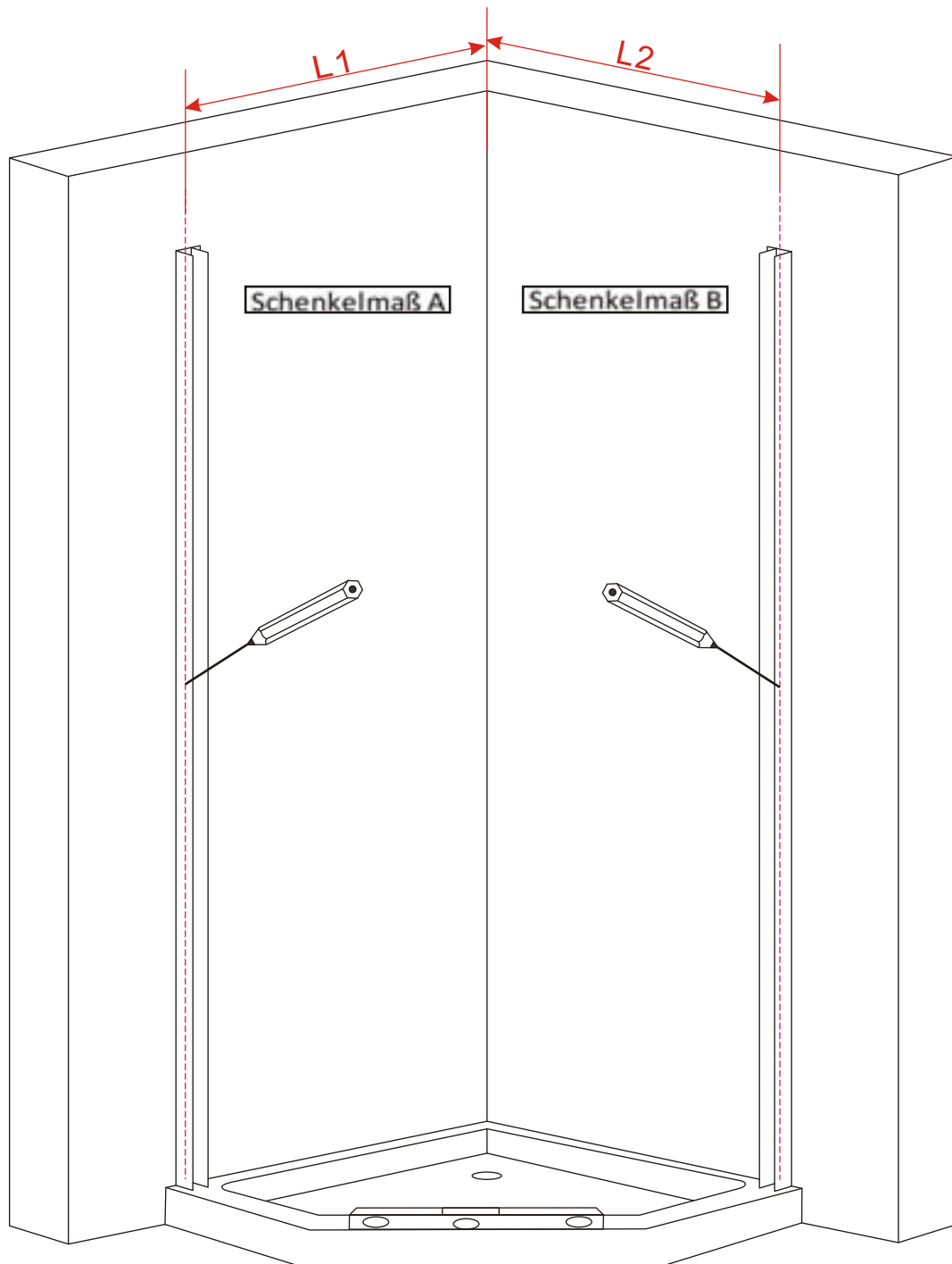

1. Stellen Sie die Wandprofile vertikal auf, nehmen Sie auch hier eine Wasserwaage zur Hilfe
2. Markieren Sie die Bohr-Löcher
3. Bohren Sie an der Markierung, setzen Sie die Dübel in die Wand
4. Schrauben Sie die Profile an die Wand

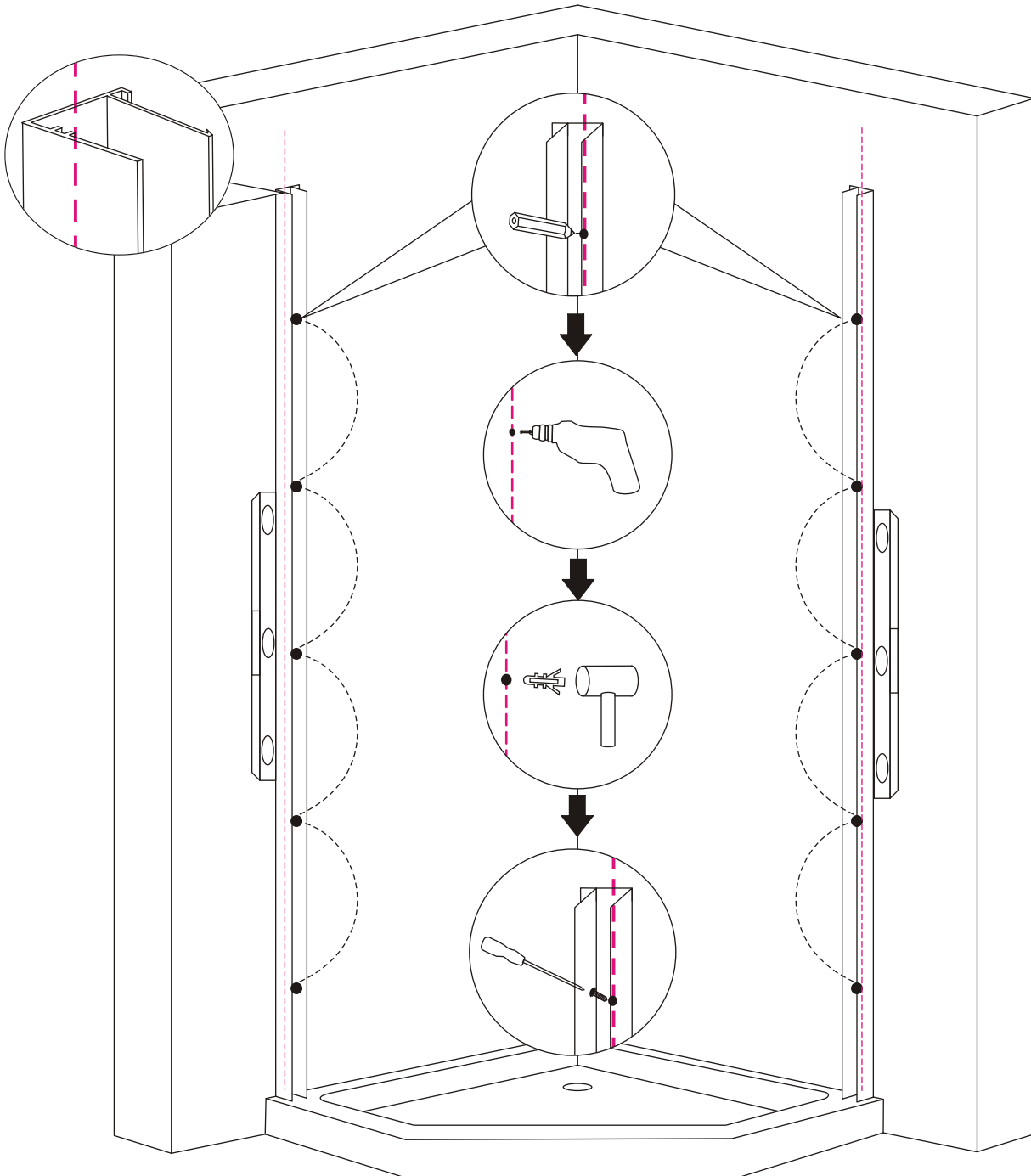
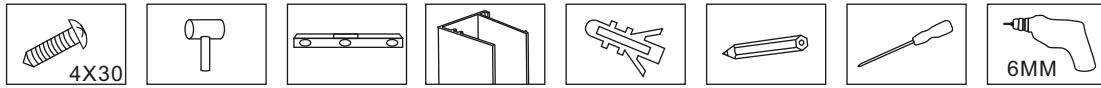

Führen Sie vorsichtig die beiden Wand-Elemente in die jeweiligen Wandprofile, lassen Sie den Kantenschutz am Glas

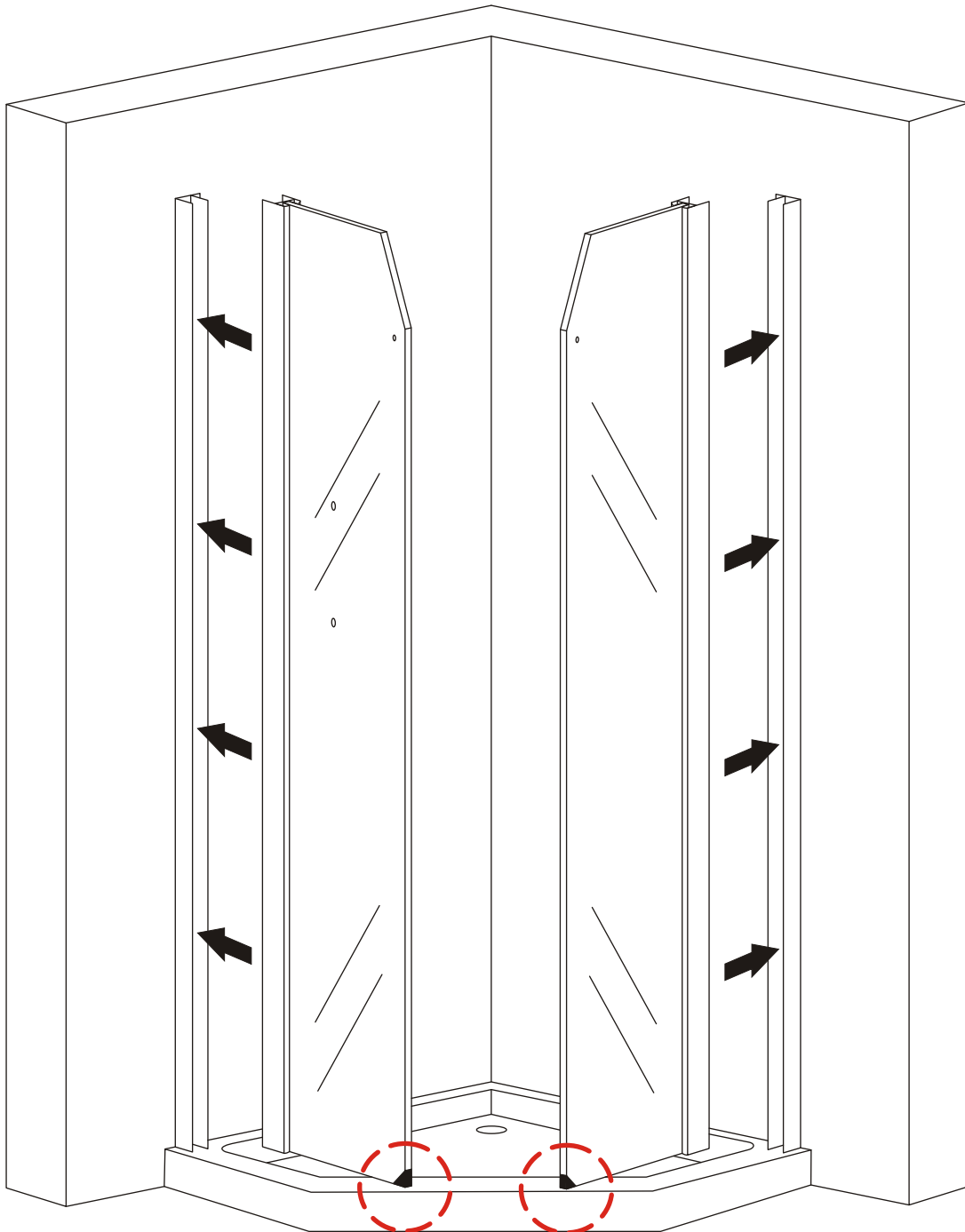

Installieren Sie den oberen und unteren Bügel, in der später die Tür ein-
gehangen wird, entsprechend der Abbildung

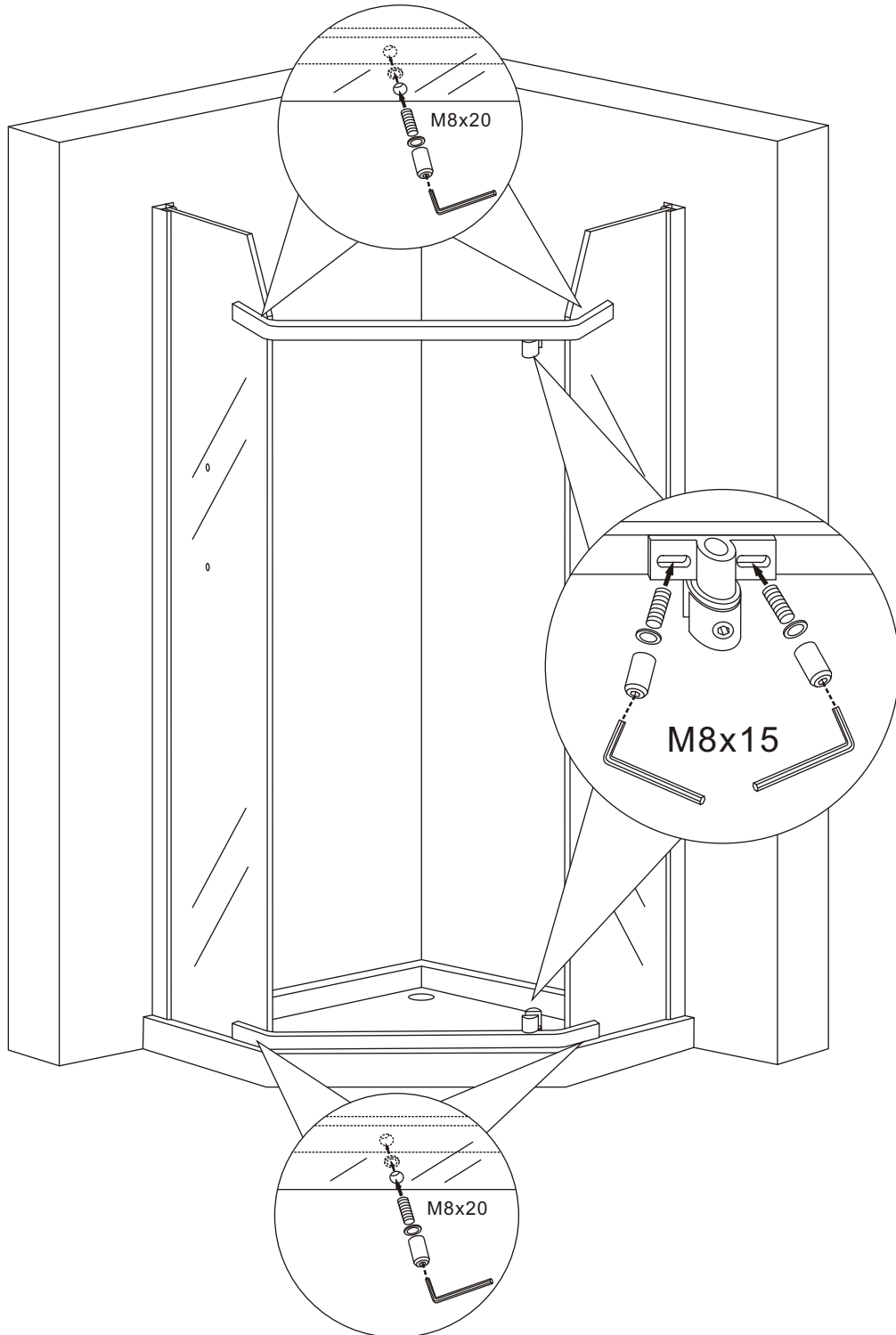
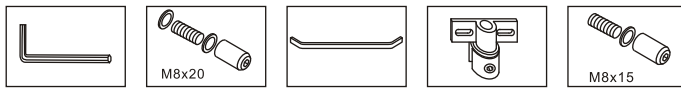

Bringen Sie die untere Tür-Dichtung sowie die vertikalen Magnetleisten an, lassen Sie die Tür-Dichtung überstehen und senken Sie die Magnetleisten von oben auf „stoß“

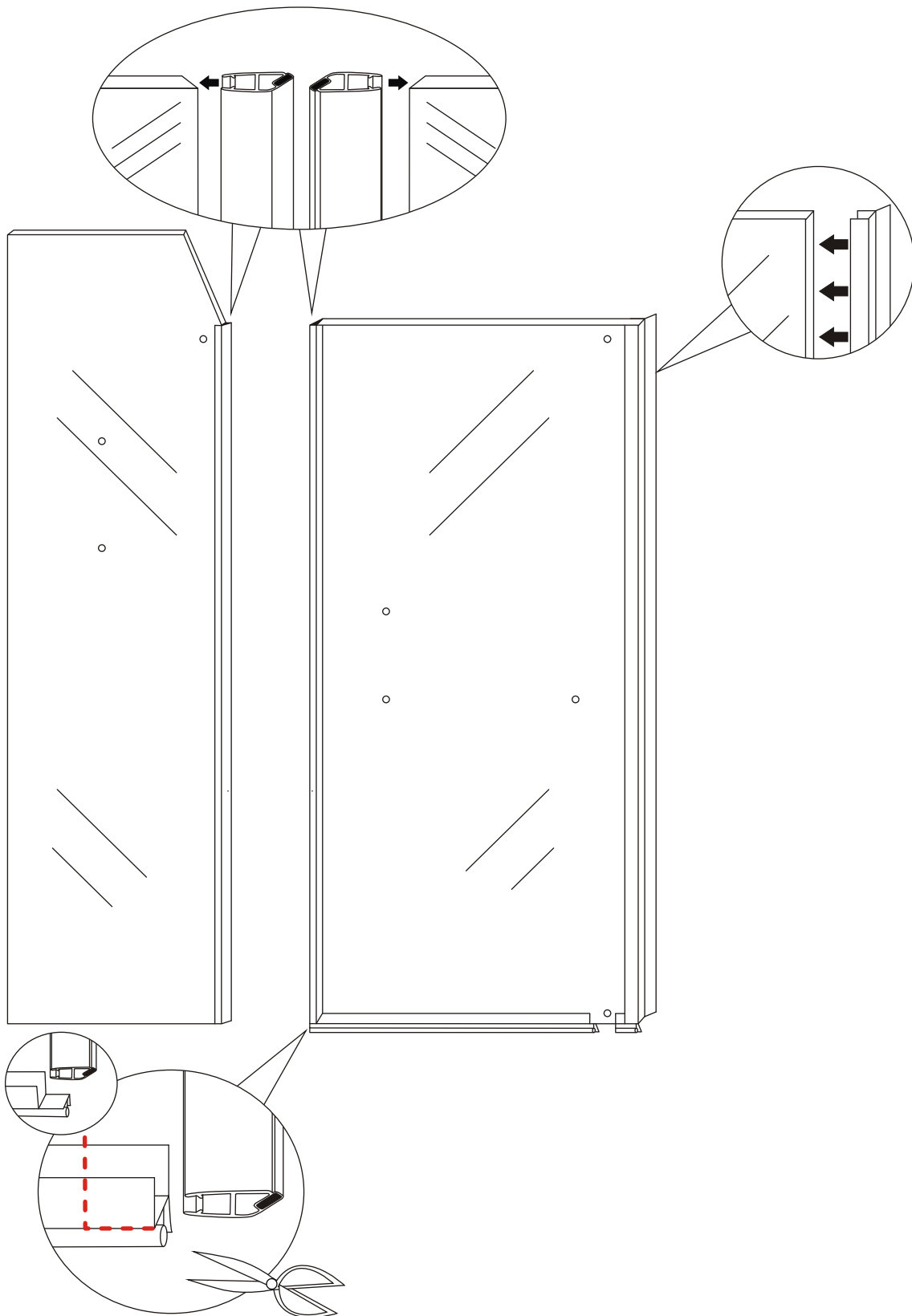
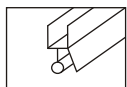
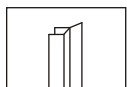

1. Hängen Sie die Tür ein und fixieren Sie diese wie abgebildet
2. Richten Sie nun die beiden Wand-Elemente aus
3. Bohren Sie anschließend wie abgebildet an den vorgesehenen Stellen durch die Wandprofile und fixieren Sie die Wand-Elemente mittels der beigefügten Schrauben
4. Bringen Sie die Abdeckkleisten zwecks Verdeckung der Verschraubung sowie die oberen Profilabdeckungen an

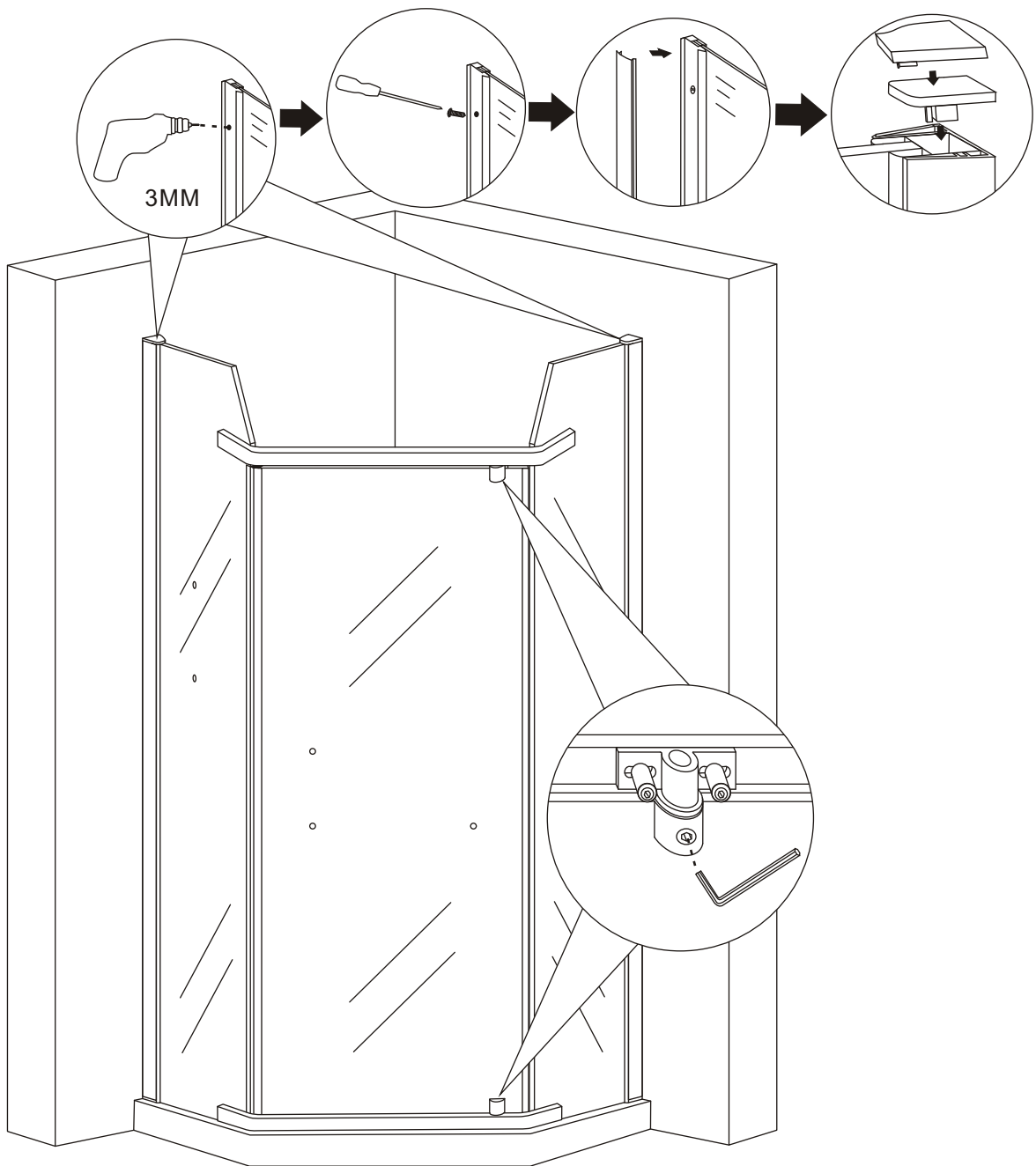
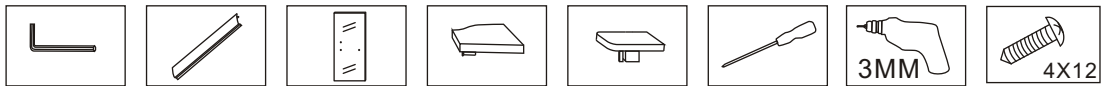

Installieren Sie das Glas-Wandregal entsprechend der Abbildung, bitte einen Halter im Glas und zwei in der Wand montieren

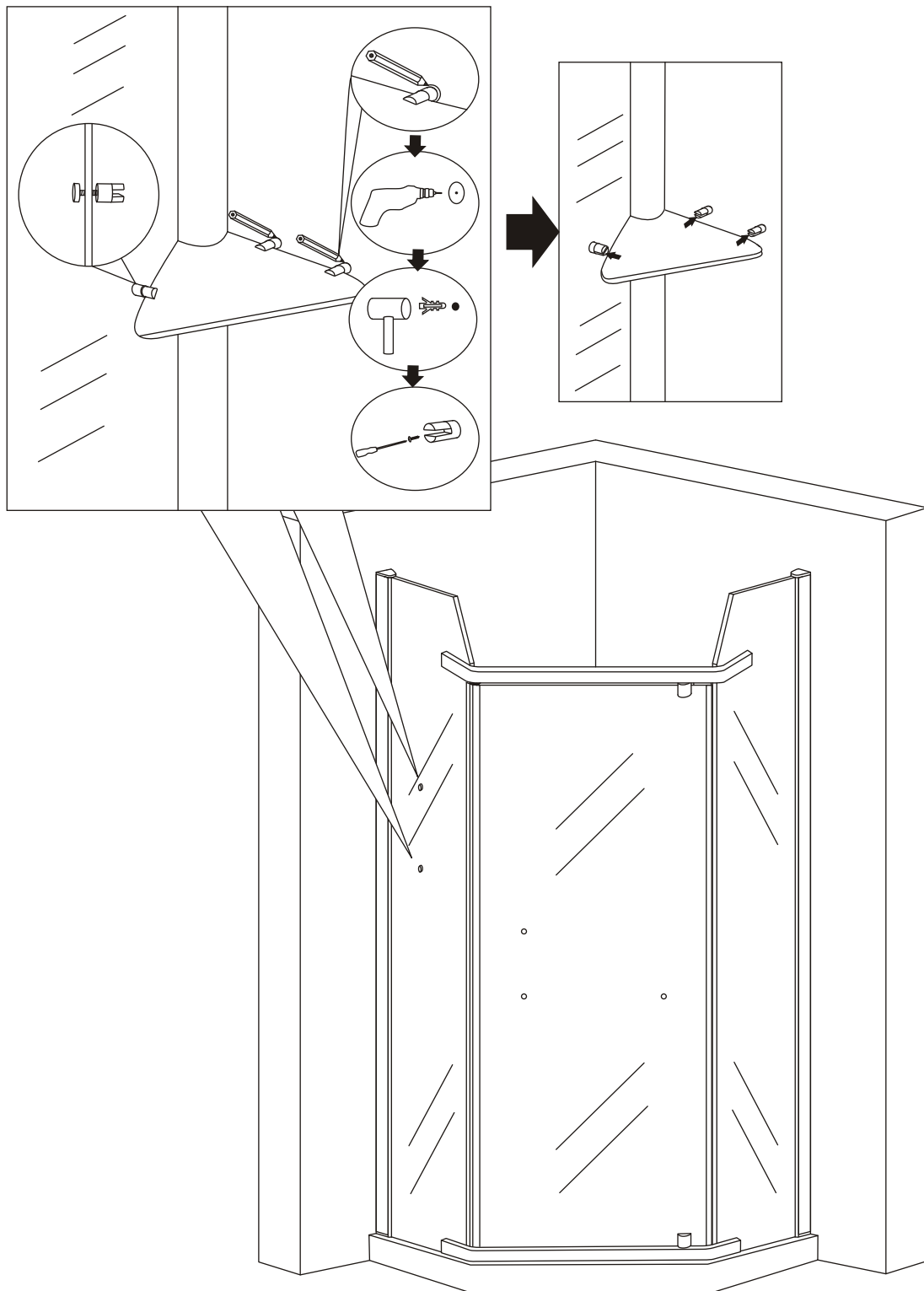
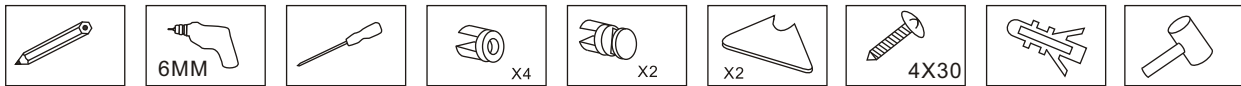

Verschrauben Sie den Türgriff und versiegeln Sie die Wand-Elemente sowie den unteren Bügel von innen & außen mittels Silikon

