

Aufbauanleitung Duschabtrennung

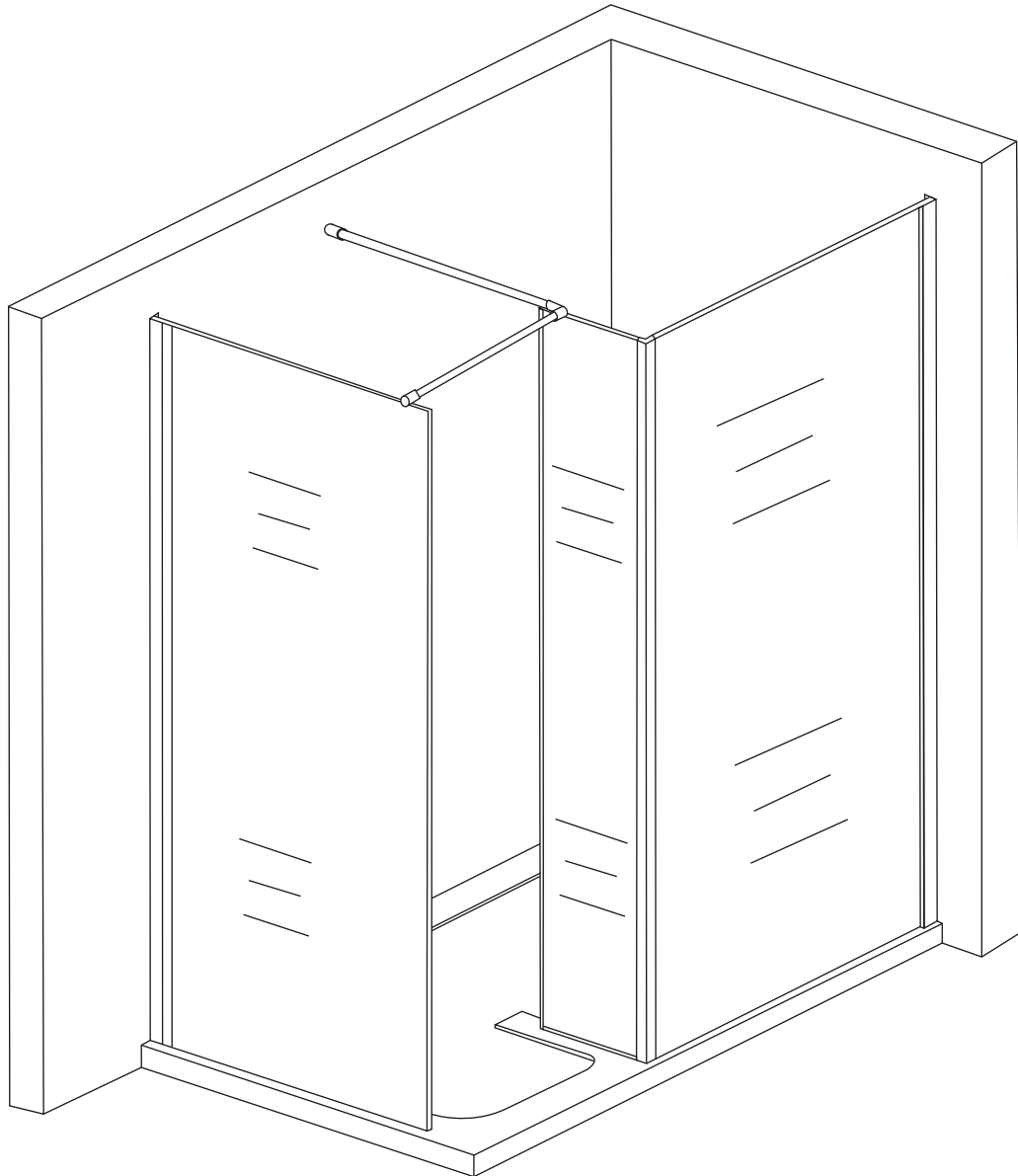

3060
RoHS **CE** **ISO9001:2000**

Benötigtes Werkzeug

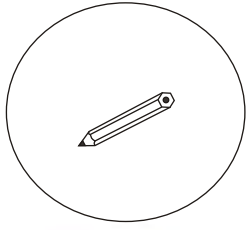

Bleistift

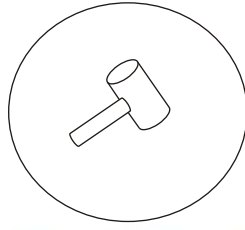

Gummi-Hammer

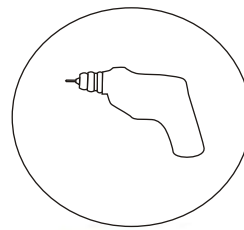

Bohrer

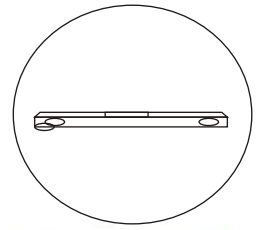

Wasserwaage

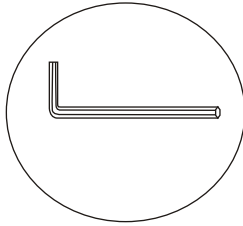

Inbusschlüssel

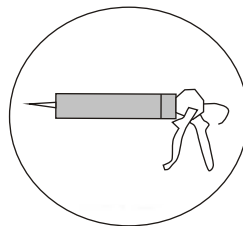

Silikon

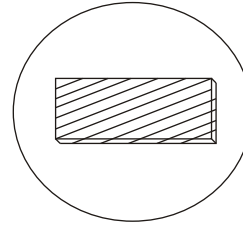

Keil

Teilleiste

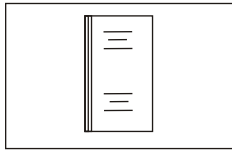

Glass

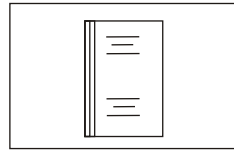

Glass

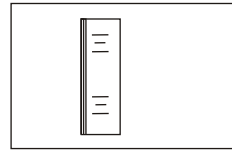

Glass

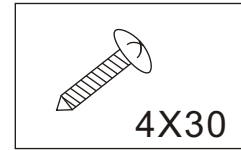

Screw

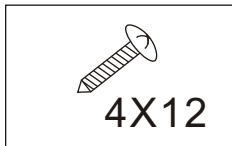

Screw

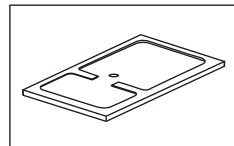

Tray

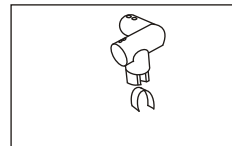

PJ-4414

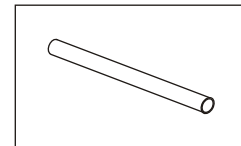

LG-2004

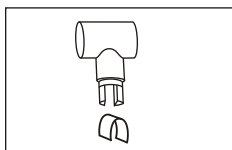

PJ-4416

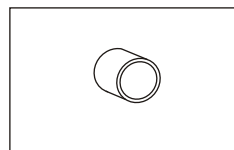

PJ-4451

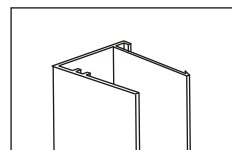

Wall profile

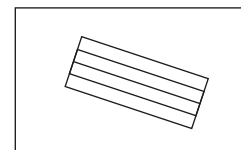

Gasket

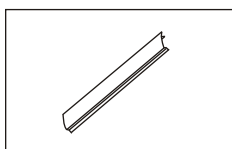

Side cover

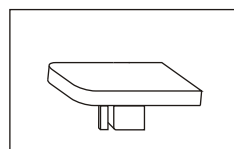

PJ-4509

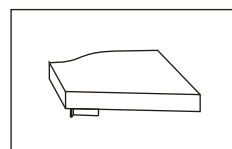

PJ-4514/
PJ-4515

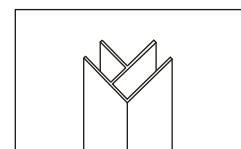

Corner aluminum
profile

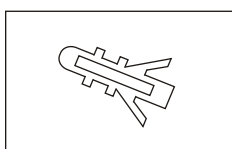

Expand tube

Maße Duschabtrennung	Schenkel 1 (L1)	Schenkel 2 (L2)
900X1500	1475	875

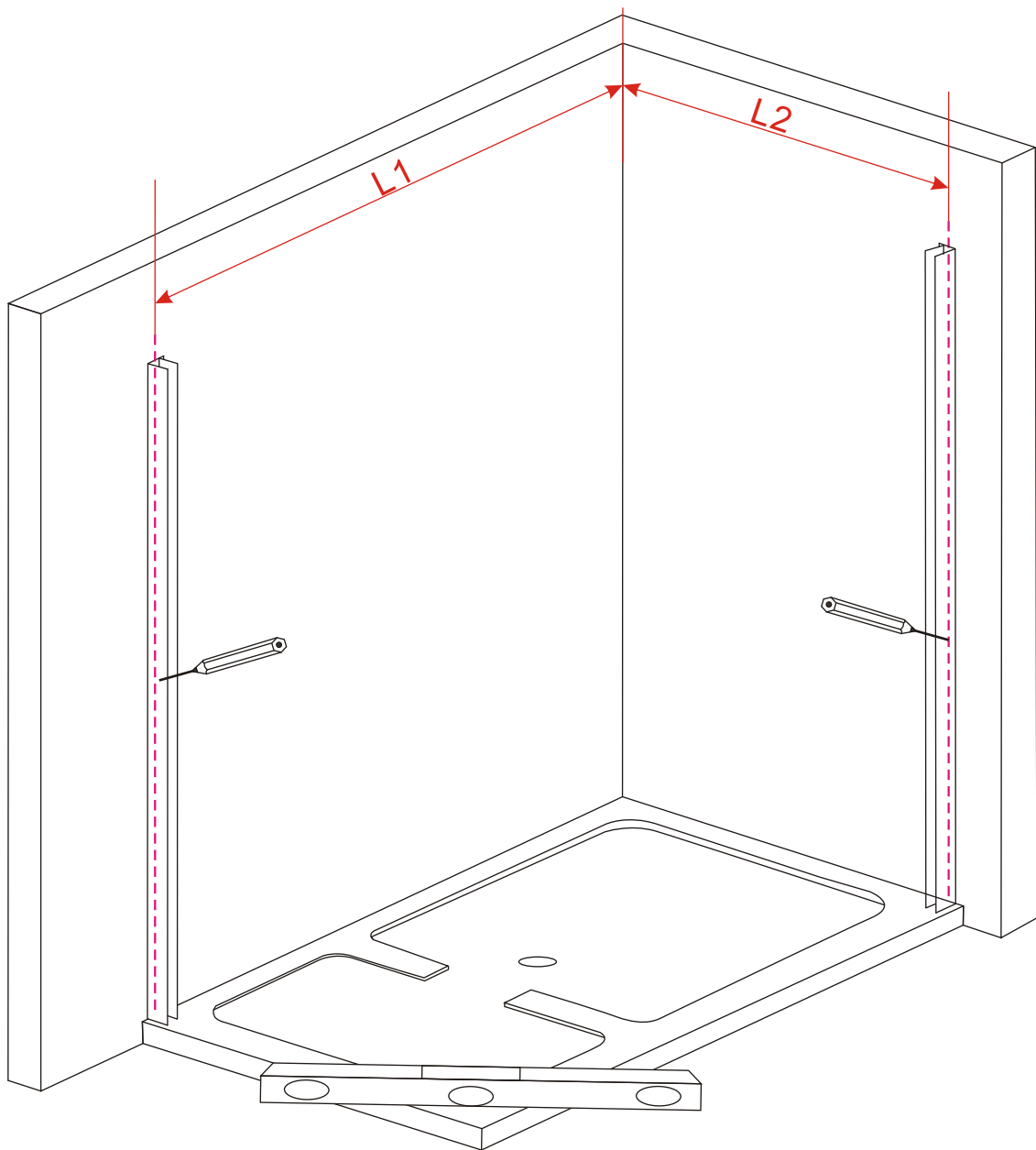

1. Platzieren Sie die Duschtasse
2. Stellen Sie die Wandprofile vertikal auf, nehmen Sie eine Wasserwaage zur Hilfe
3. Markieren Sie die Bohrlöcher
4. Bohren Sie an der Markierung und setzen die Dübel in die Wand
5. Schrauben Sie die Wandprofile an die Wand

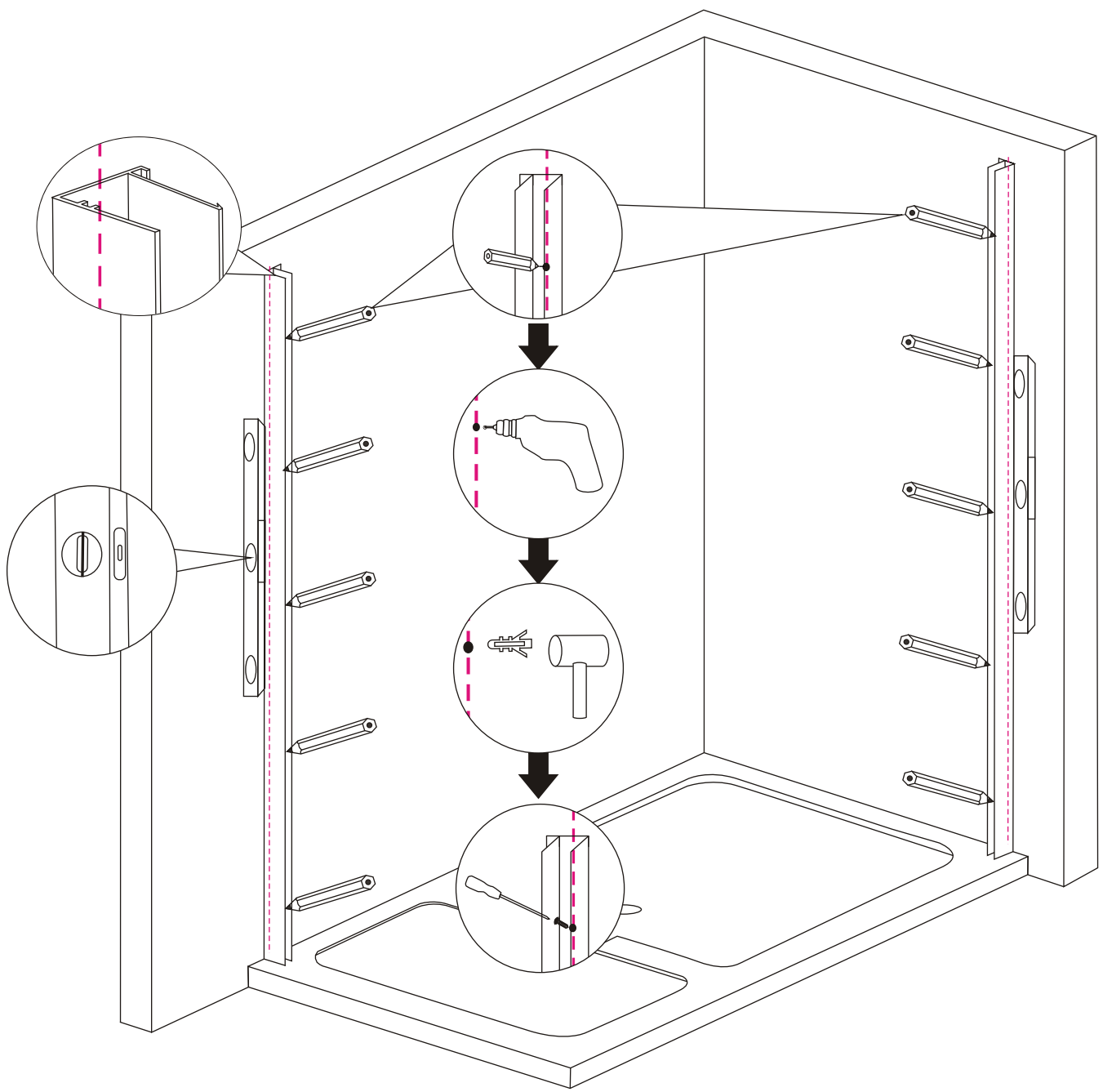
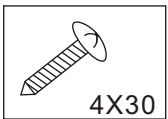
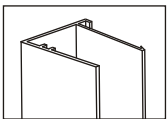
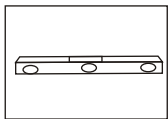
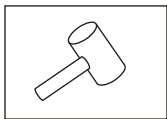
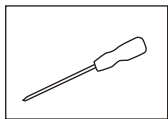
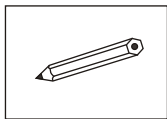
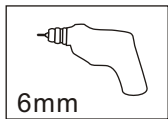

Führen Sie vorsichtig das große Front-Element in das Wandprofil, lassen Sie dabei den Kantenschutz am Glas

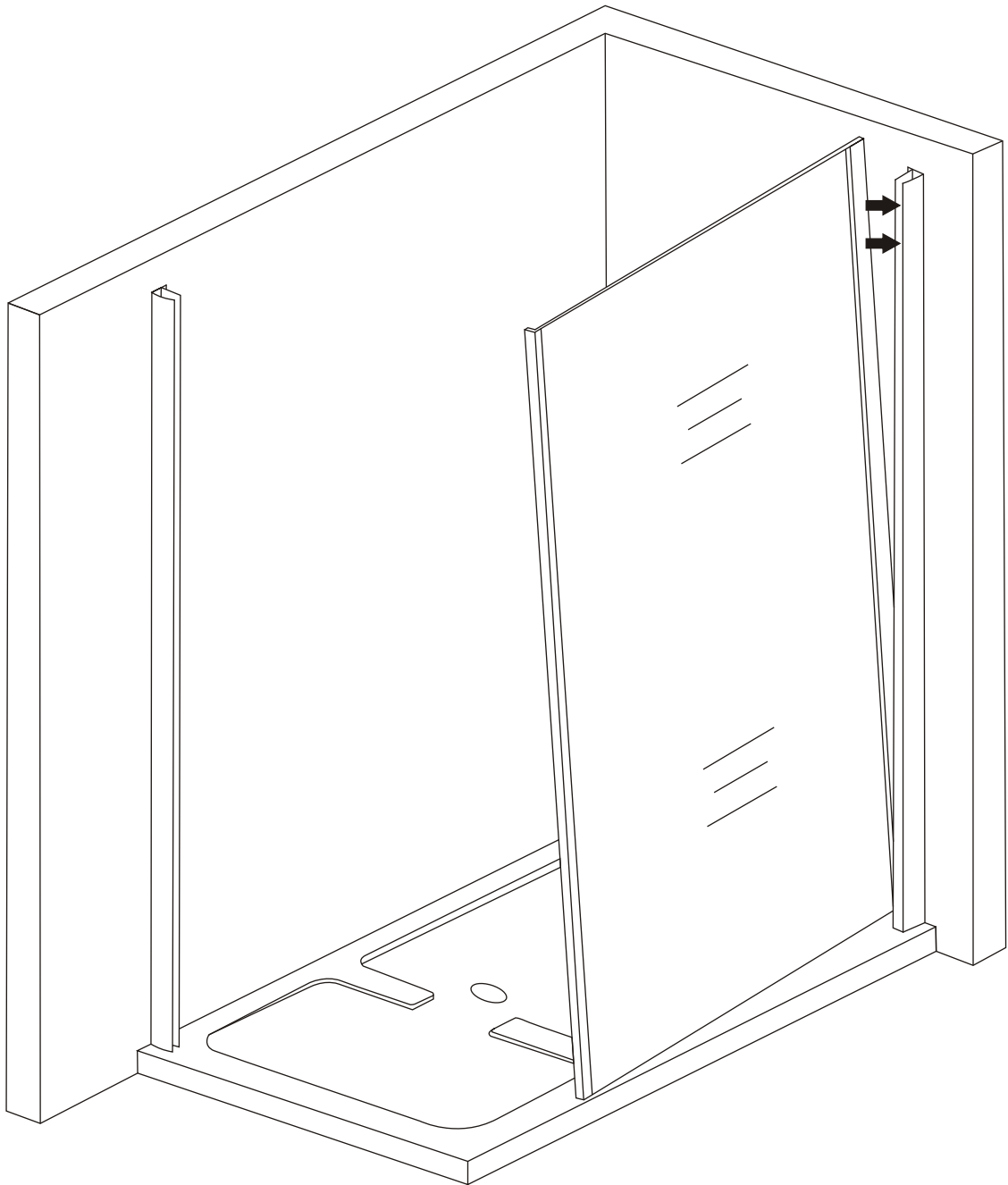
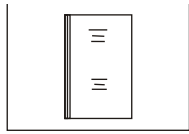

Spritzen Sie Silikon in das Eck-Profil der Anbauecke und Installieren Sie die Anbauecke wie abgebildet

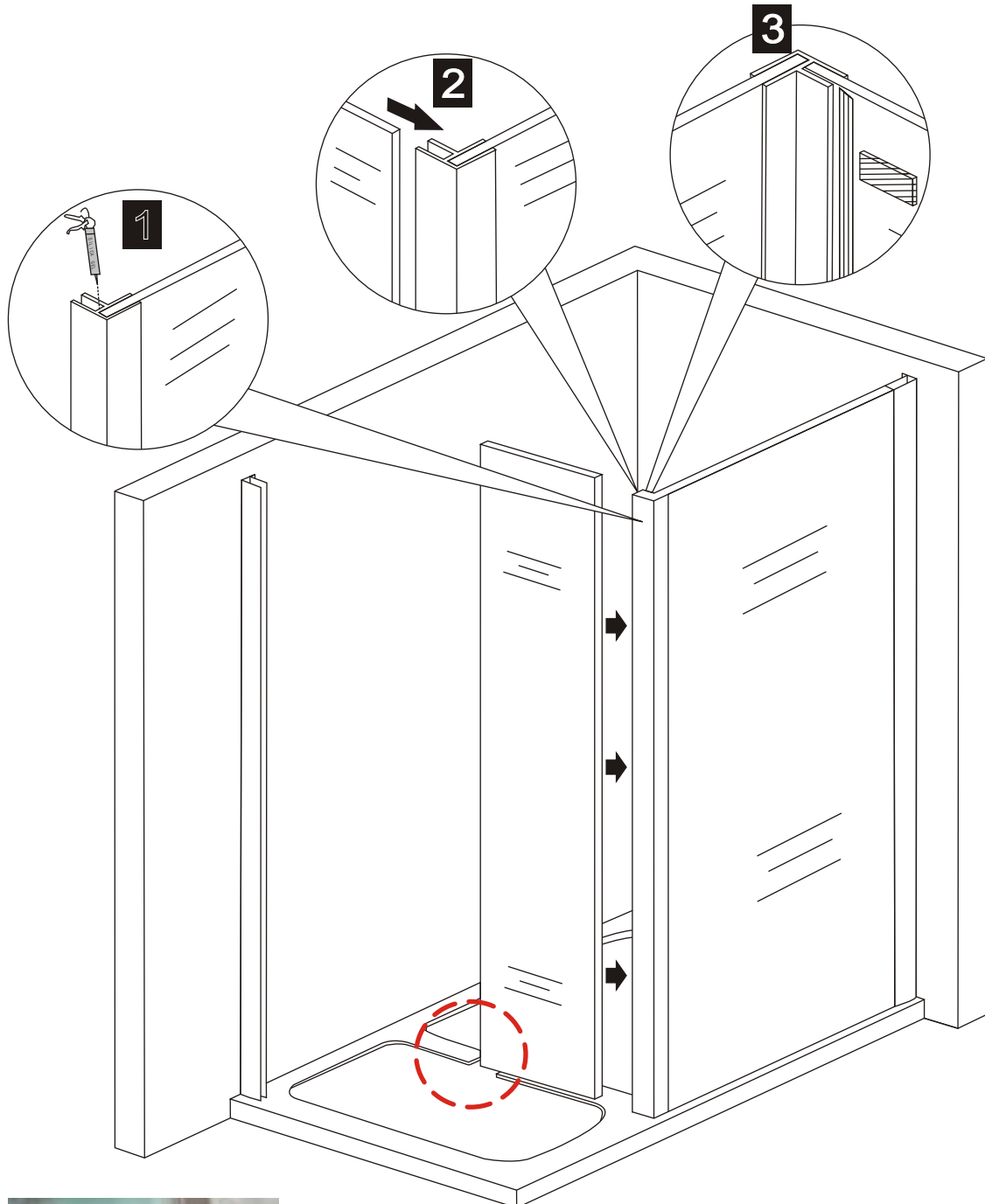
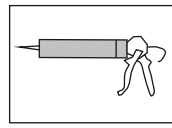
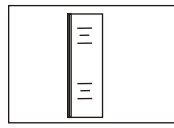
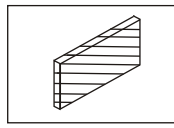
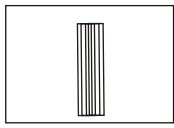

Führen Sie nun vorsichtig das seitliche Element in das Wandprofil, lassen Sie auch hier den Kantenschutz am Glas

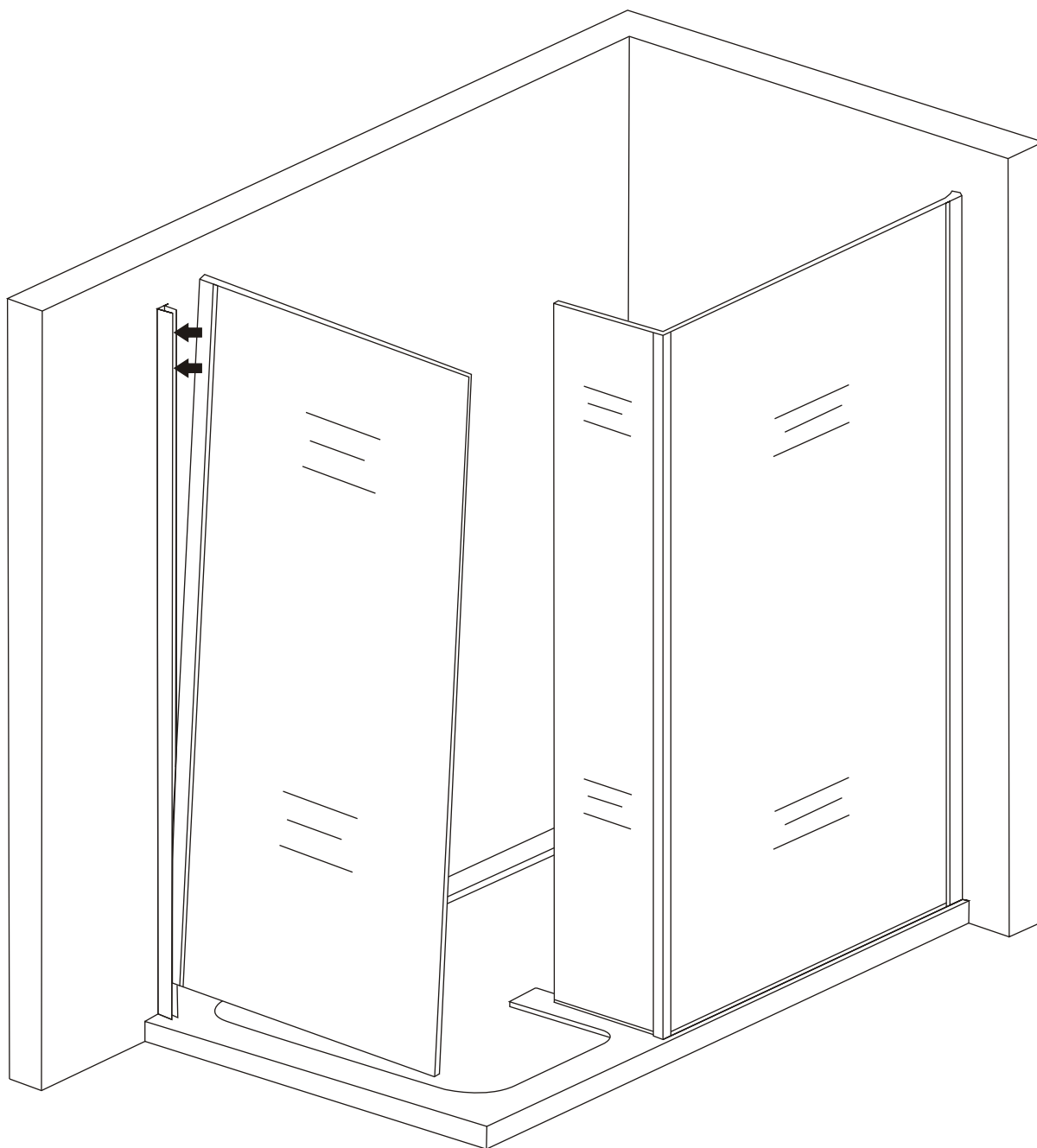
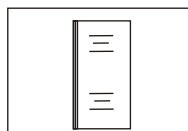

1. Bohren Sie an den vorgesehenen Stellen durch die Wandprofile und fixieren Sie das Fron- und Seitenelement mittels der beigelegten Schrauben, klinken Sie anschließend die Abdeckleiste zwecks Verdeckung der Verschraubung ein
2. Bringen Sie die Stabilisationsstange entsprechend der Abbildung an

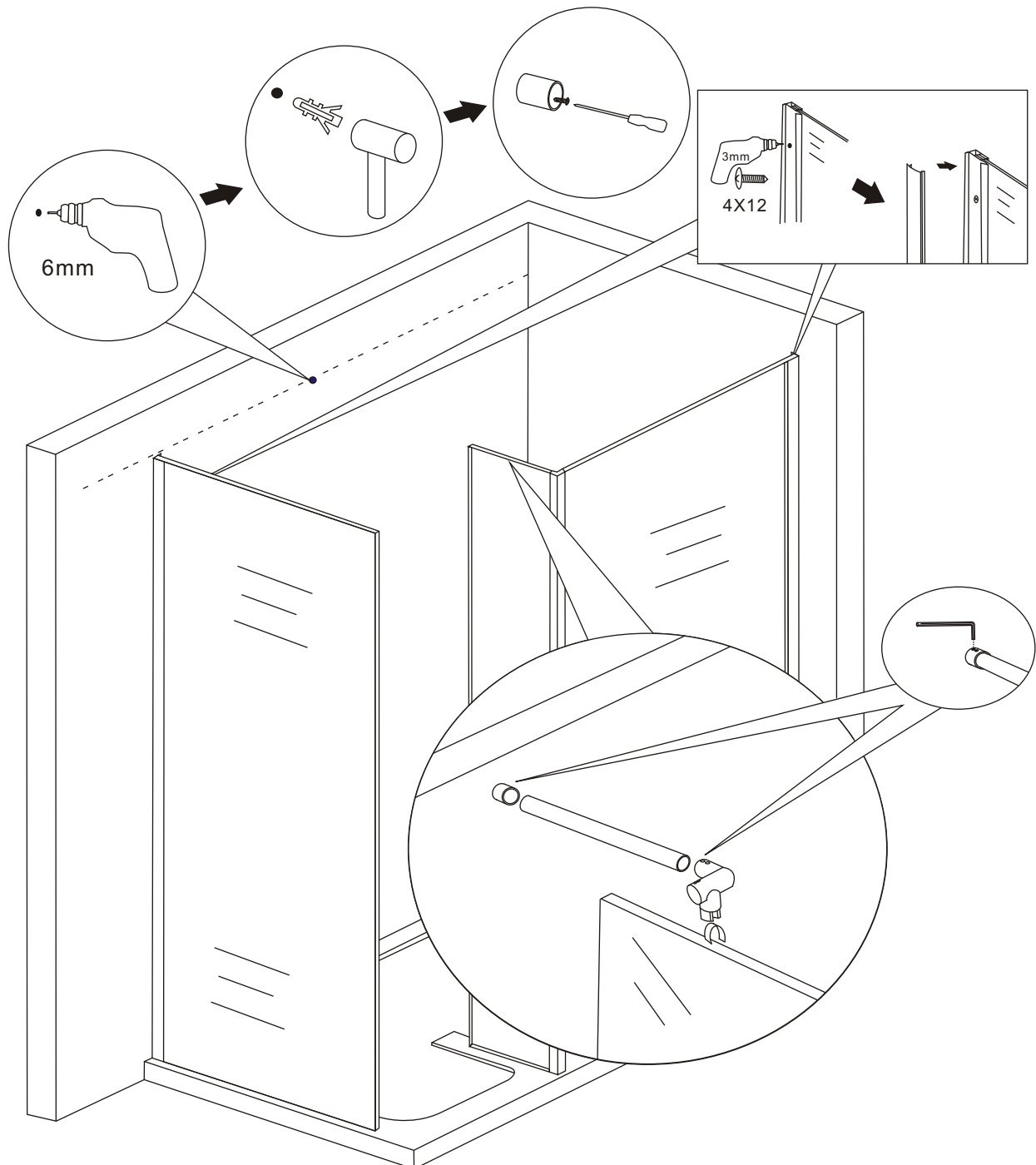
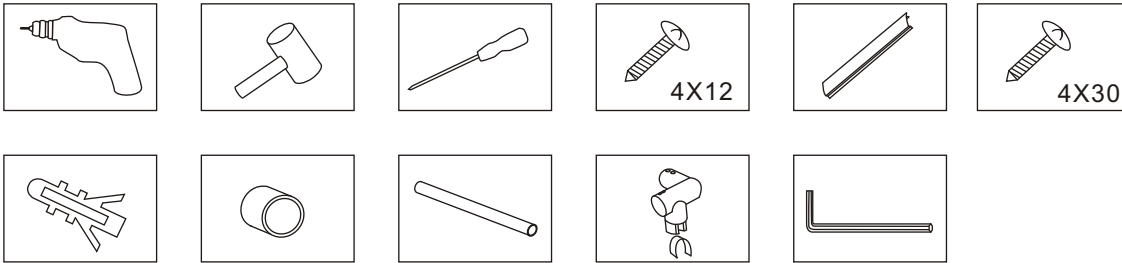

1. Installieren Sie die 2. Stabilisierungsstange wie abgebildet und bringen Sie die oberen Profilabdeckungen an
2. Versiegeln Sie die Duschabtrennung von Innen & Außen mittels Silikon

