

INSTALLATION MANUAL

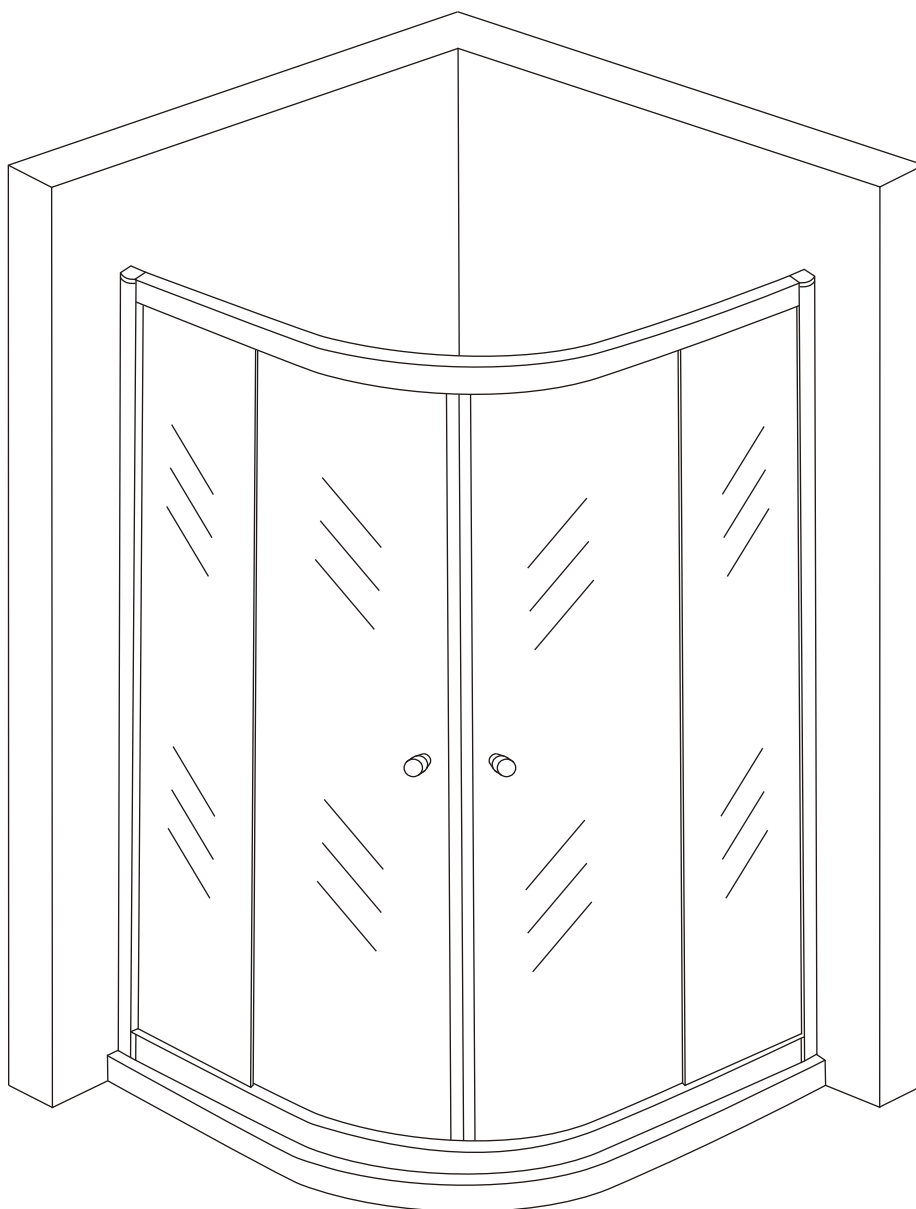

3187/3188

RoHS **CE** **ISO9001:2000**

Benötigtes Werkzeug

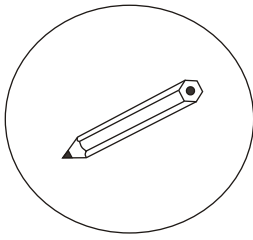

Bleistift

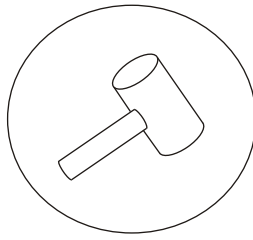

Gummi-Hammer

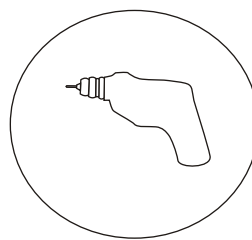

Bohrer

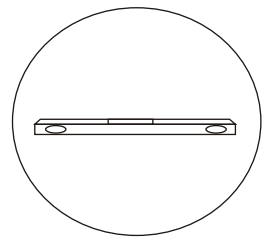

Wasserwaage

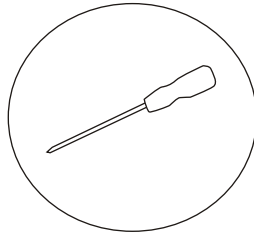

Schraubendreher

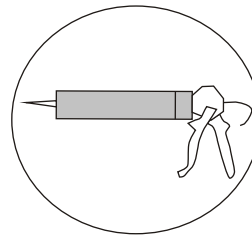

Silikon-Gel

Teileliste

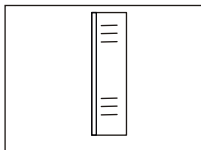

Glass

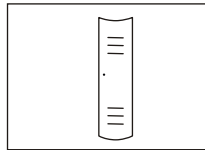

Glass

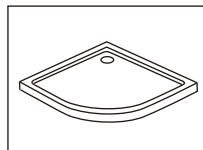

Tray

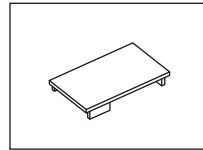

PJ-4616

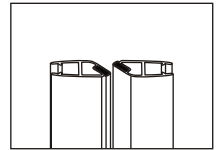

CT-8BMX90

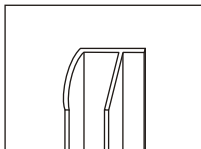

Wall profile

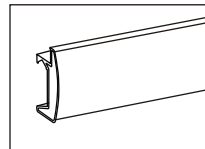

Track

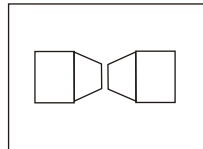

LS-1201

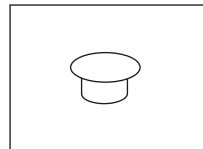

PJ-4617

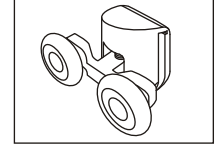

LZ-5018

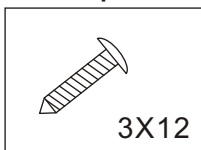

3X12

Screw

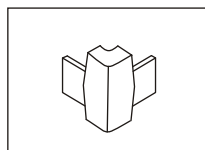

PJ-4625

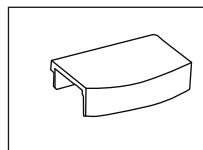

PJ-4615

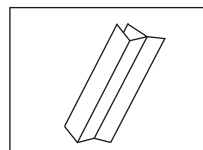

CT-8DST90

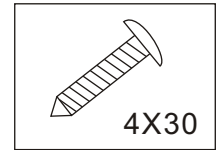

4X30

Screw

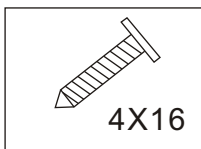

4X16

Screw

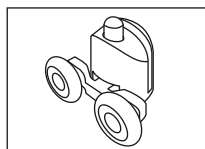

LZ-5018

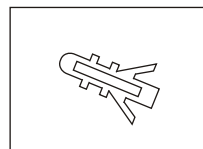

Expand tube

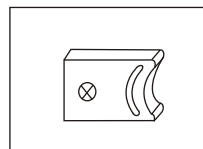

PJ-4626

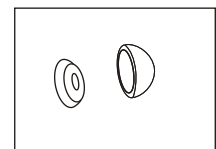

PJ-4553

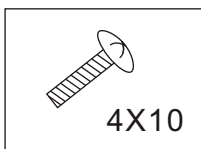

4X10

Screw

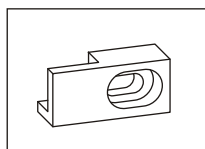

PJ-4684/
PJ-4685

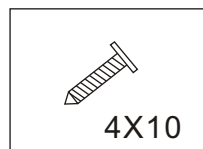

4X10

Screw

Verbinden Sie die untere und obere Laufführung bzw. den Rahmen mit den beiden Wandgläsern entsprechend der Abbildung

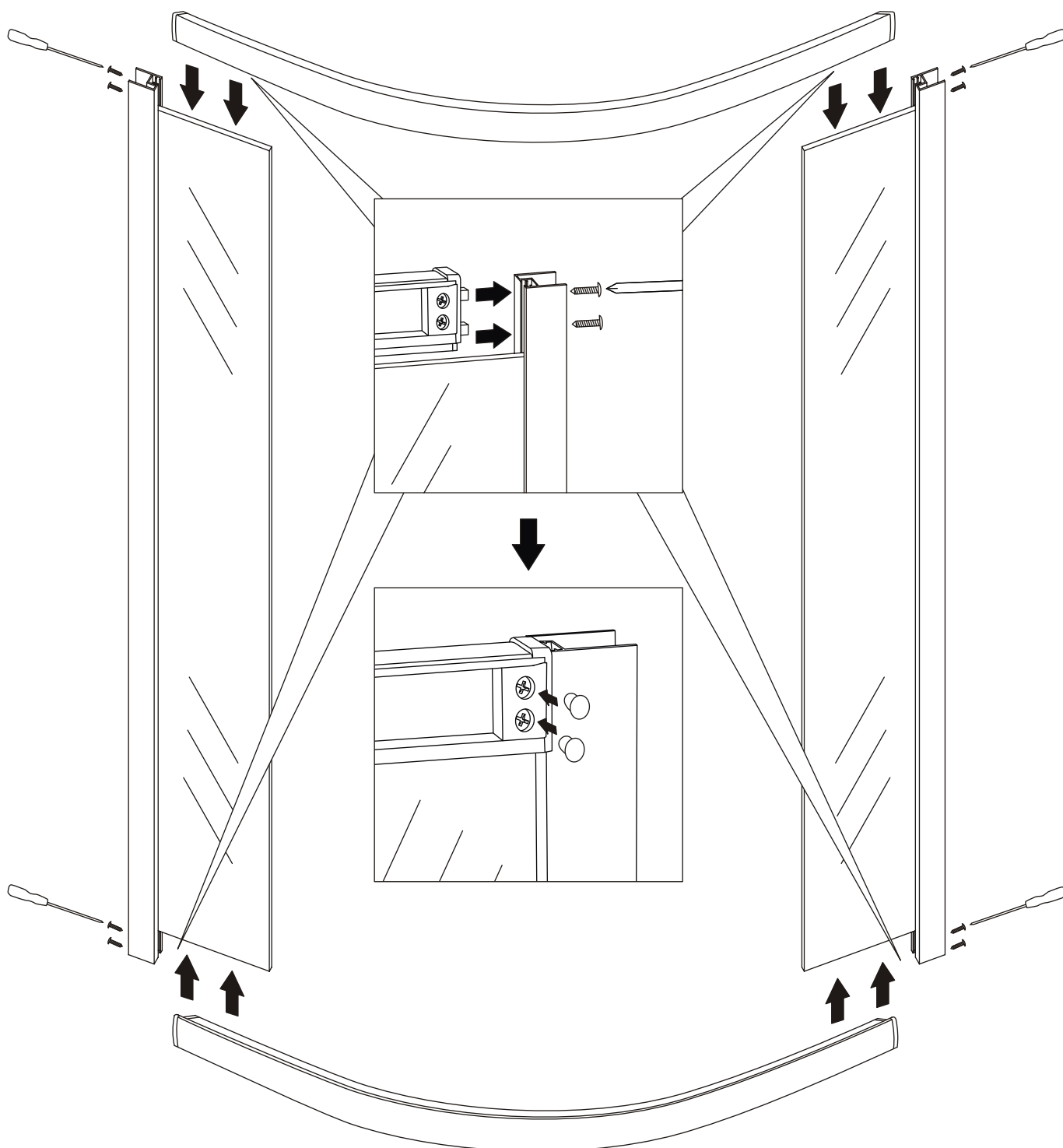
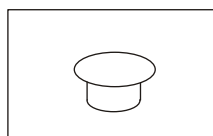
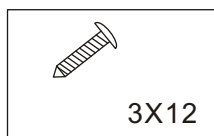
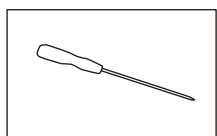

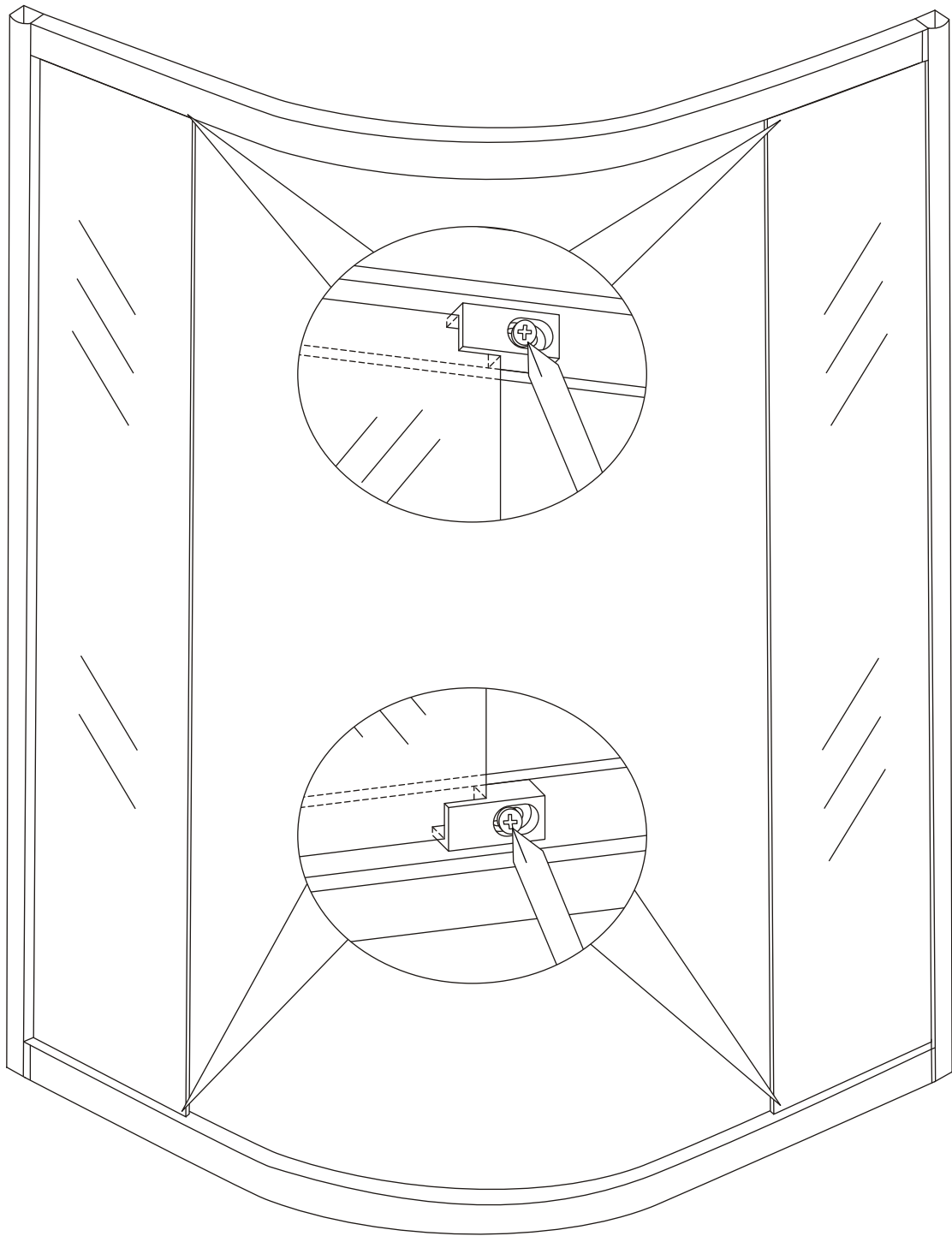
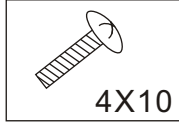
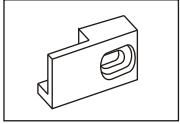

Bringen Sie die beiden Wandprofile an den feststehenden Elementen
an

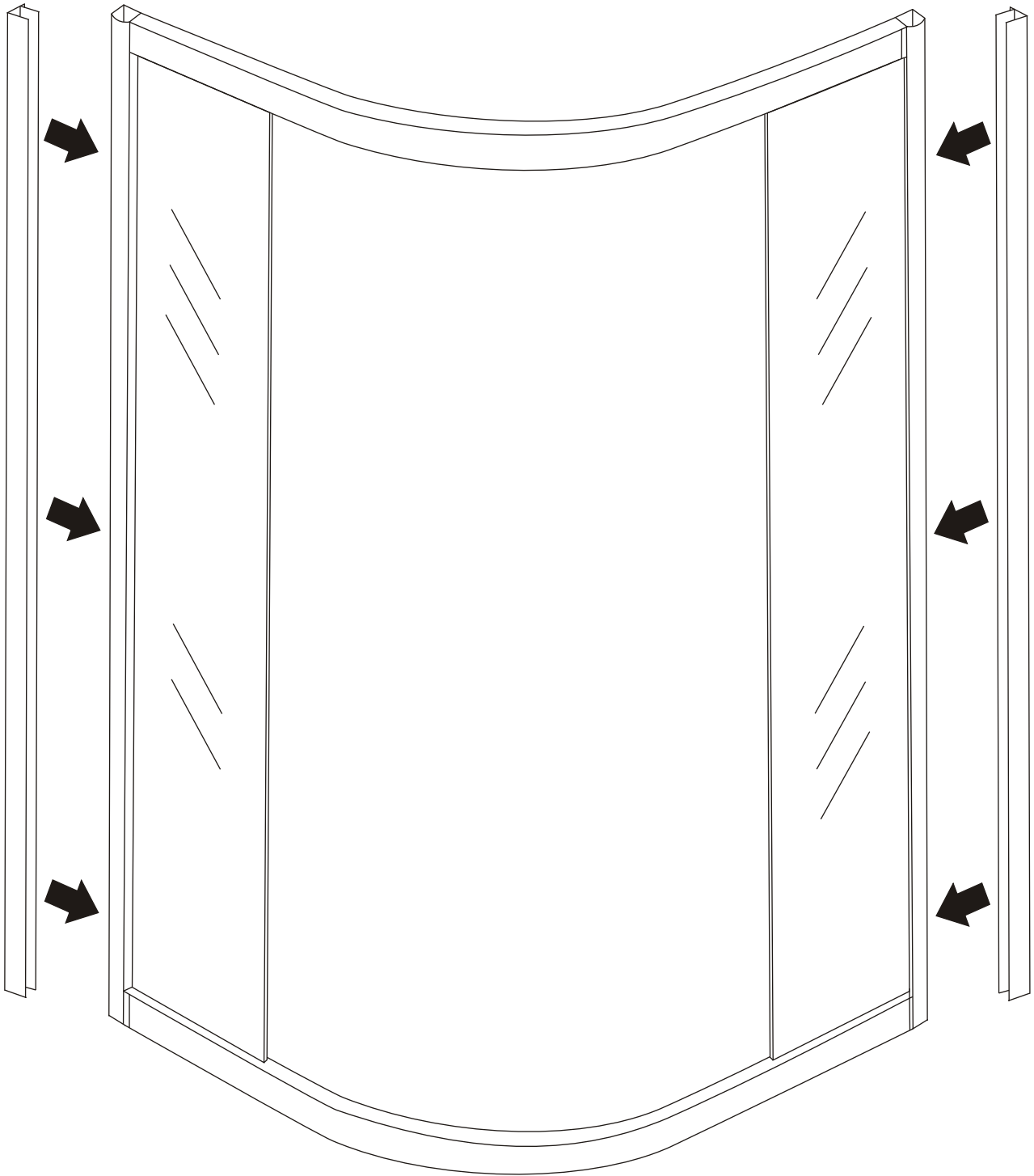
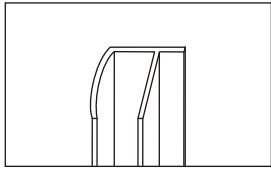

Markieren Sie die Bohrlöcher durch anhalten der Wandprofile
(die Vorbohrungen im Wandprofil müssen sich auf der
Montagelinie befinden), nehmen Sie eine Wasserwaage zur Hilfe.
Installieren Sie anschließend die Wandprofile

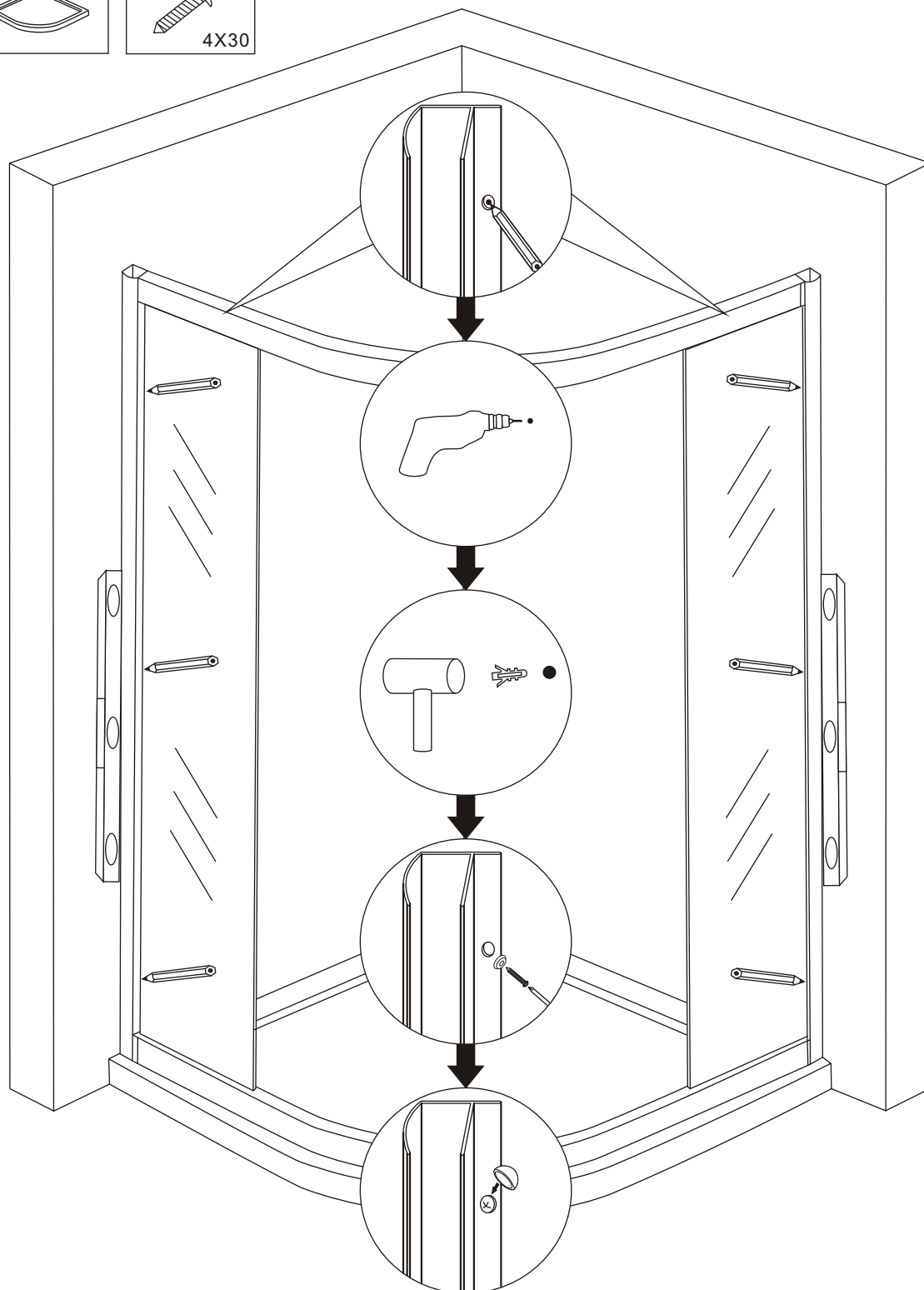
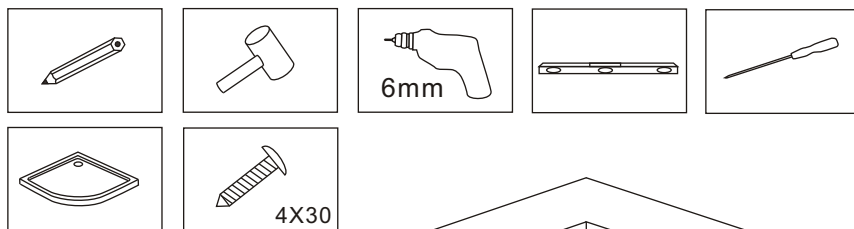

Bohren Sie an den vorgesehenen Stellen durch die Wandprofile und fixieren Sie die feststehenden Elemente mittels der beigegefügten Schrauben, bringen Sie anschließend die Kappen auf die Schraubenköpfe und klinken die die Blende am Wandprofil ein

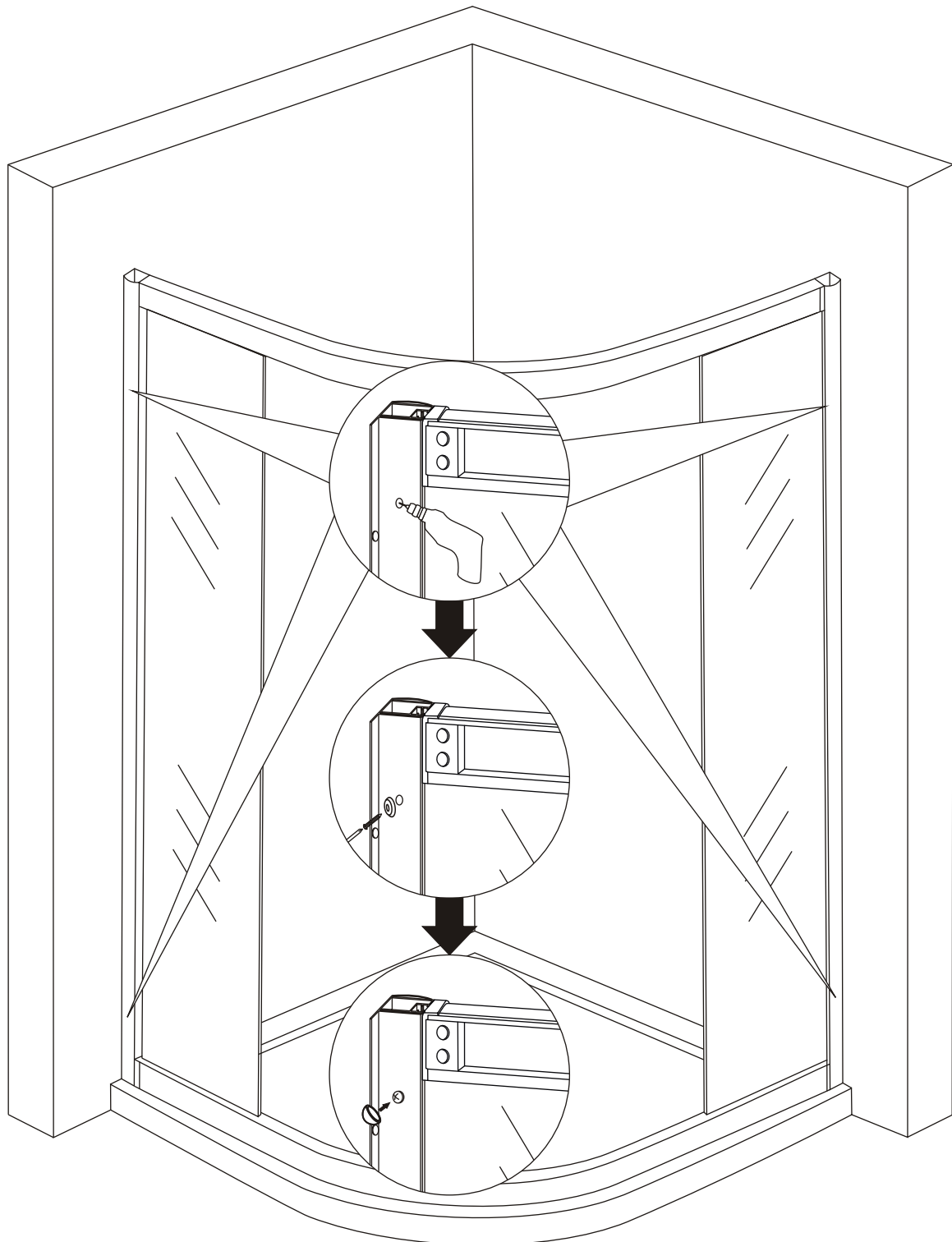
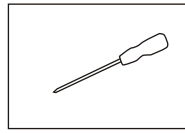
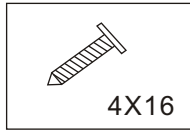
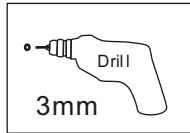
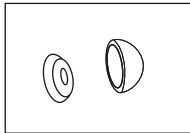

1. Bringen Sie die Laufrollen an den Tür-Gläsern an, die oberen Laufrollen können nach erfolgter Montage justiert werden
2. Bringen Sie jeweils zwischen Tür- & Wand-Glas eine vertikale Dichtleiste an

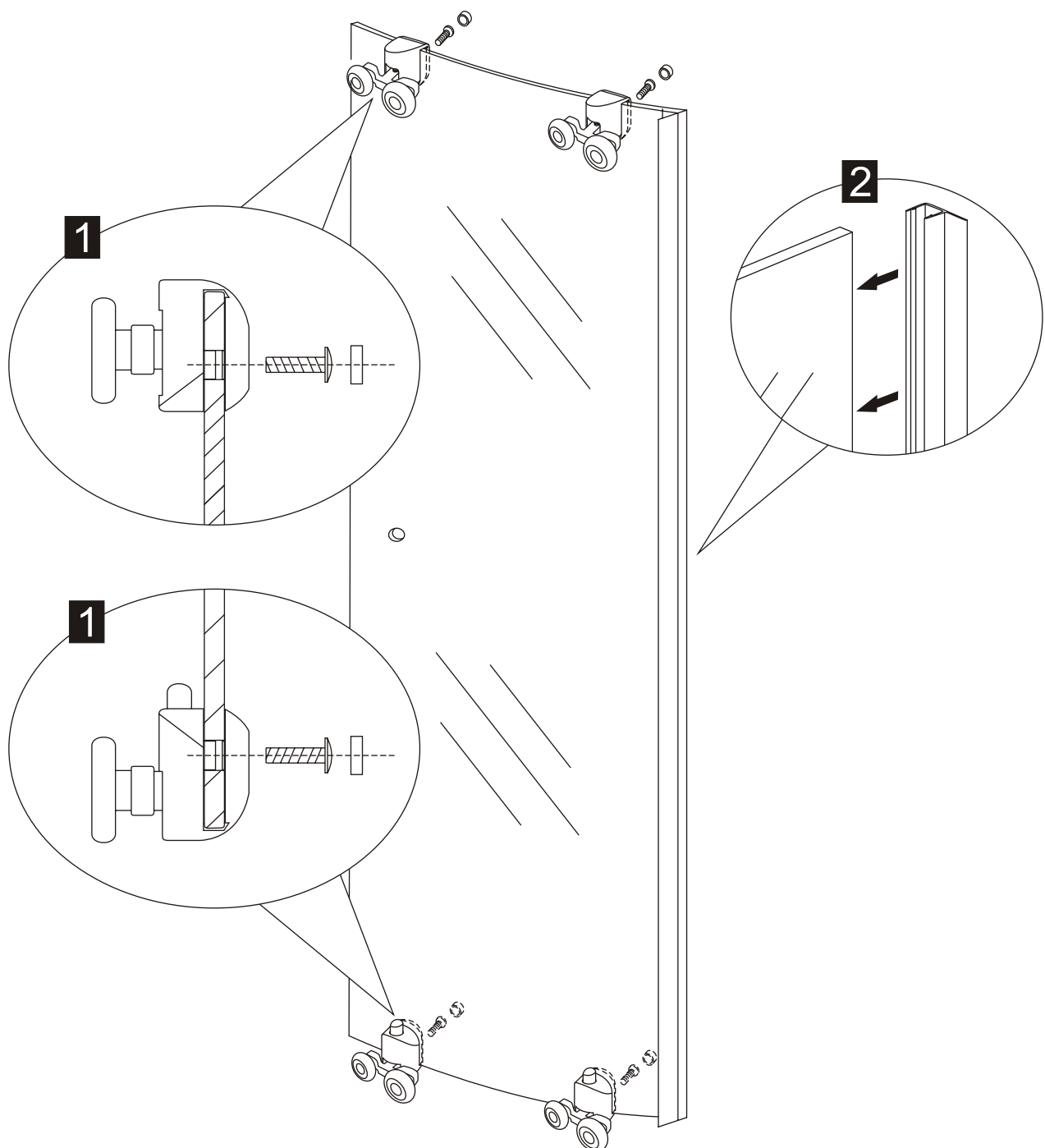
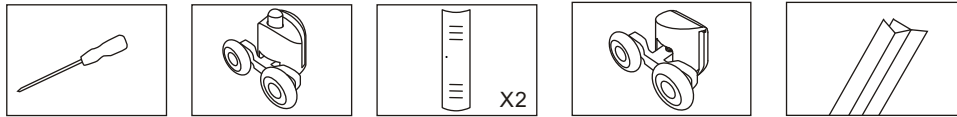

1. Hängen Sie die Tür-Gläser entsprechend der Abbildung ein
2. Bringen Sie jeweils zwischen Tür- & Wand-Glas eine vertikale Dichtleiste an

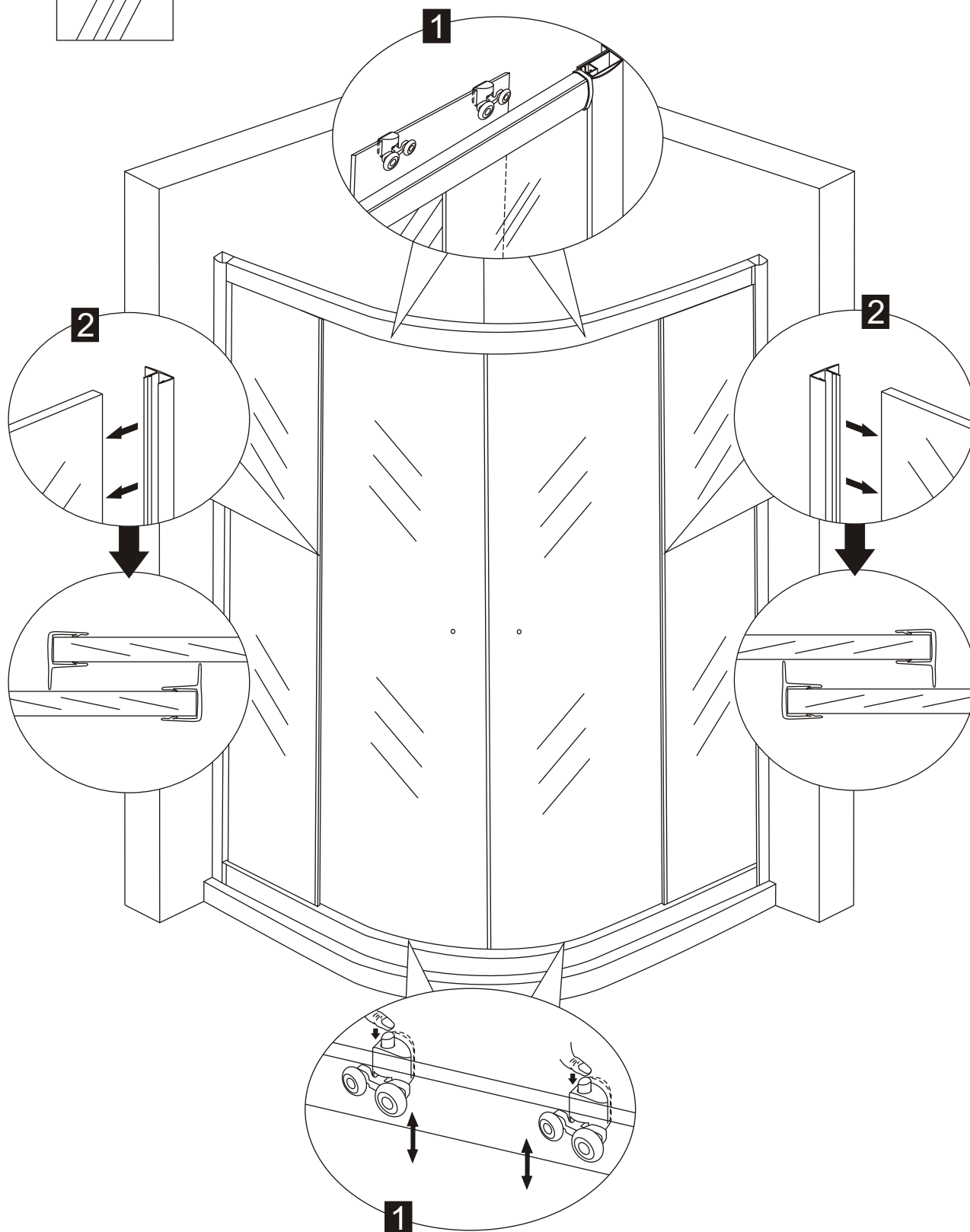
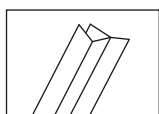

1. Bringen Sie die Türstopper an der Innenseite des Rahms an
- an
2. Installieren Sie die Magnetleisten am Einstieg
3. Verschrauben Sie die Türgriffe

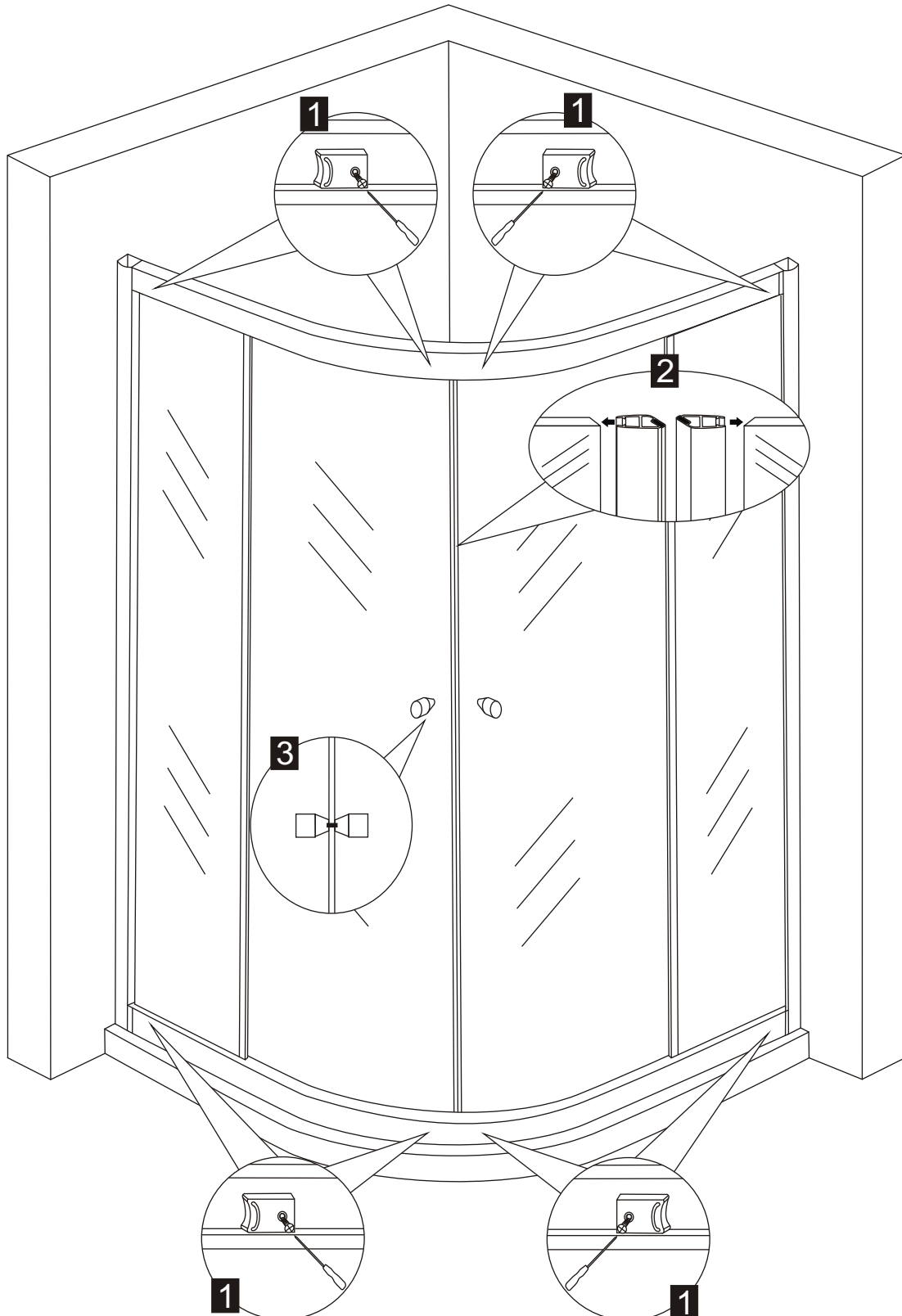
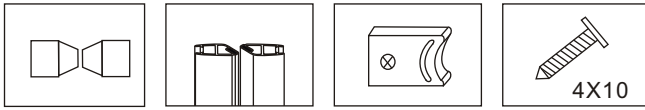

1. Stecken Sie die obere Profilabdeckung auf
2. Versiegeln Sie am Boden den Rahmen von innen & außen mittels Silikon

