

## Montageanleitung „Nischerntür“

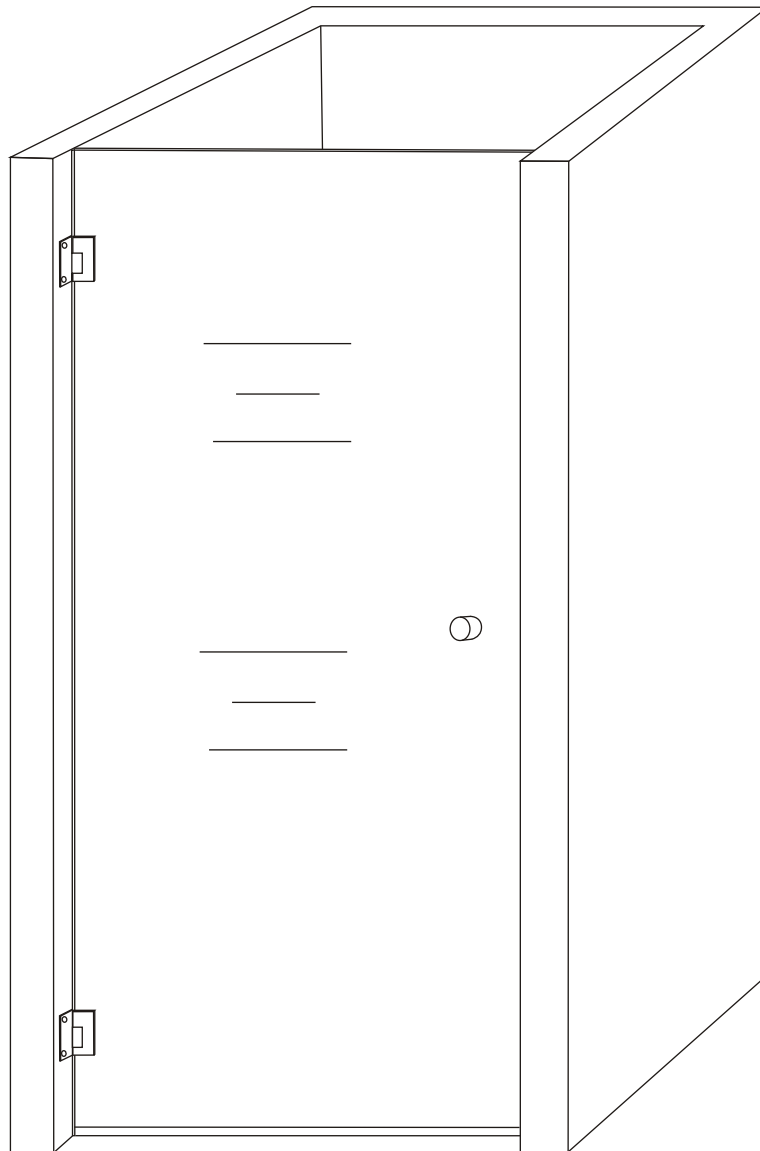

3560/3561/3562

**RoHS** **CE** **ISO9001:2000**

## Benötigtes Werkzeug

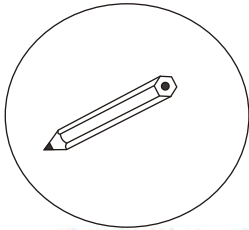

Bleistift

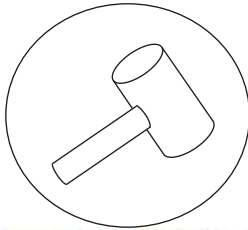

Gummi Hammer

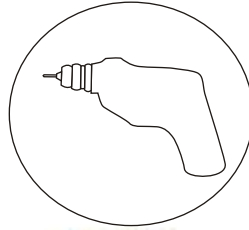

Bohrer

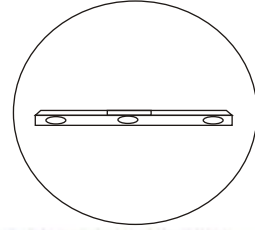

Wasserwaage

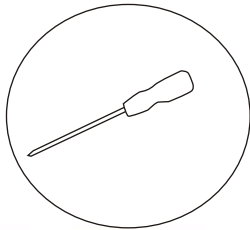

Schraubendreher

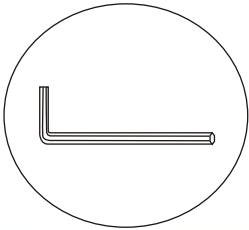

Inbusschlüssel

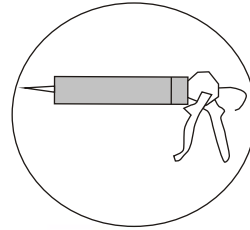

Silikon

## Teileliste

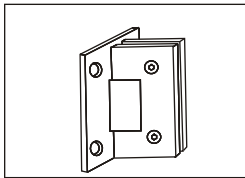

HY-3307

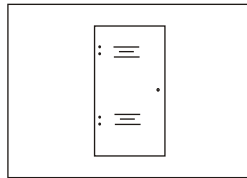

Glass

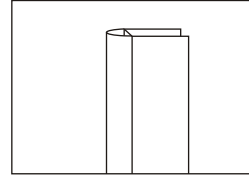

CT-8DSTC

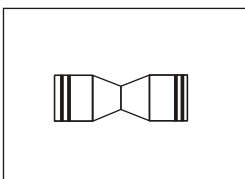

LS-1202

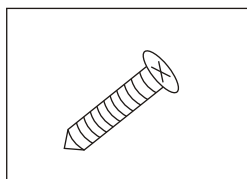

Screw

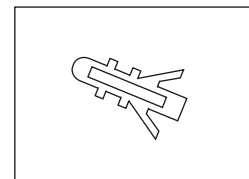

Expand tube

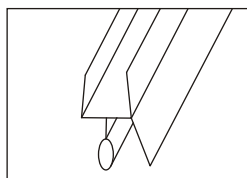

CT-8DSTQ

Verschrauben Sie die Scharniere mit dem Tür-Glas und bringen Sie die untere, sowie die beiden seitlichen, vertikalen Dichtleisten an (lassen Sie die untere Dichtleiste überstehen, die vertikalen Dichtleisten werden von oben auf „stoß“ gesenkt)

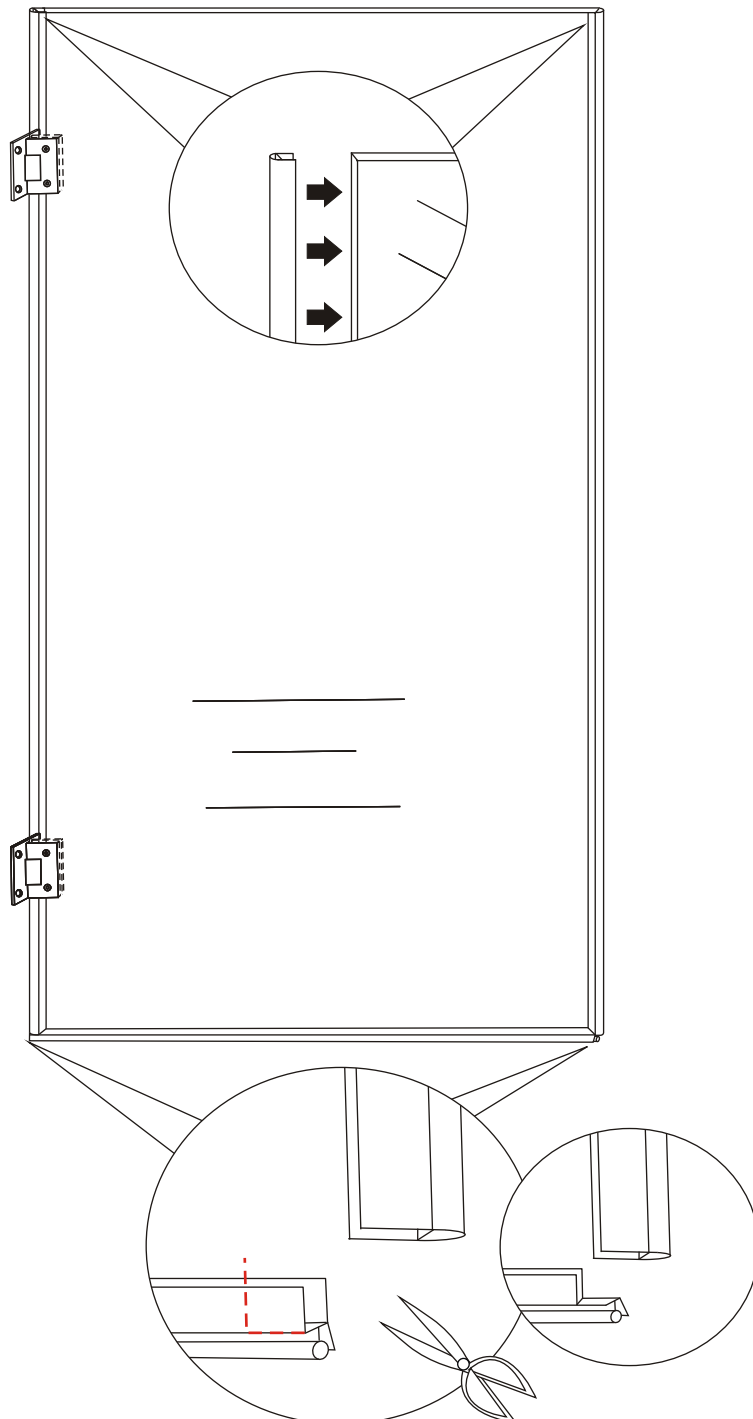
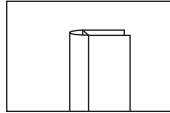
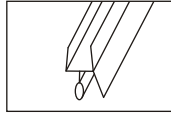
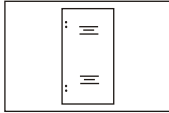

Nehmen Sie eine Wasserwaage zur Hilfe und markieren Sie die Bohrlöcher

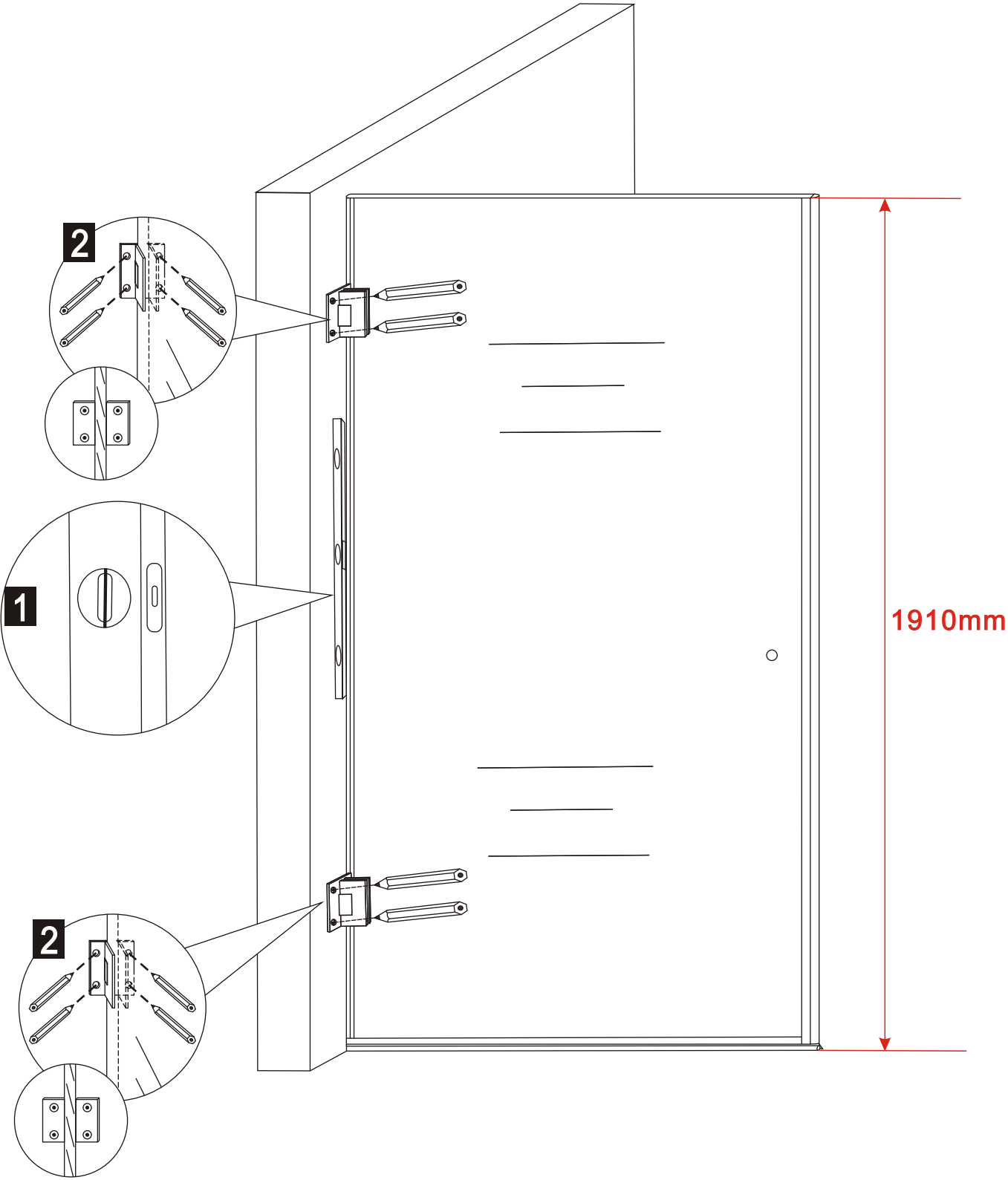
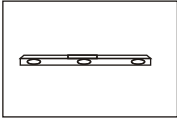
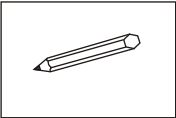

Bohren Sie an der Markierung und setzen Sie die Dübel in die Bohrlöcher

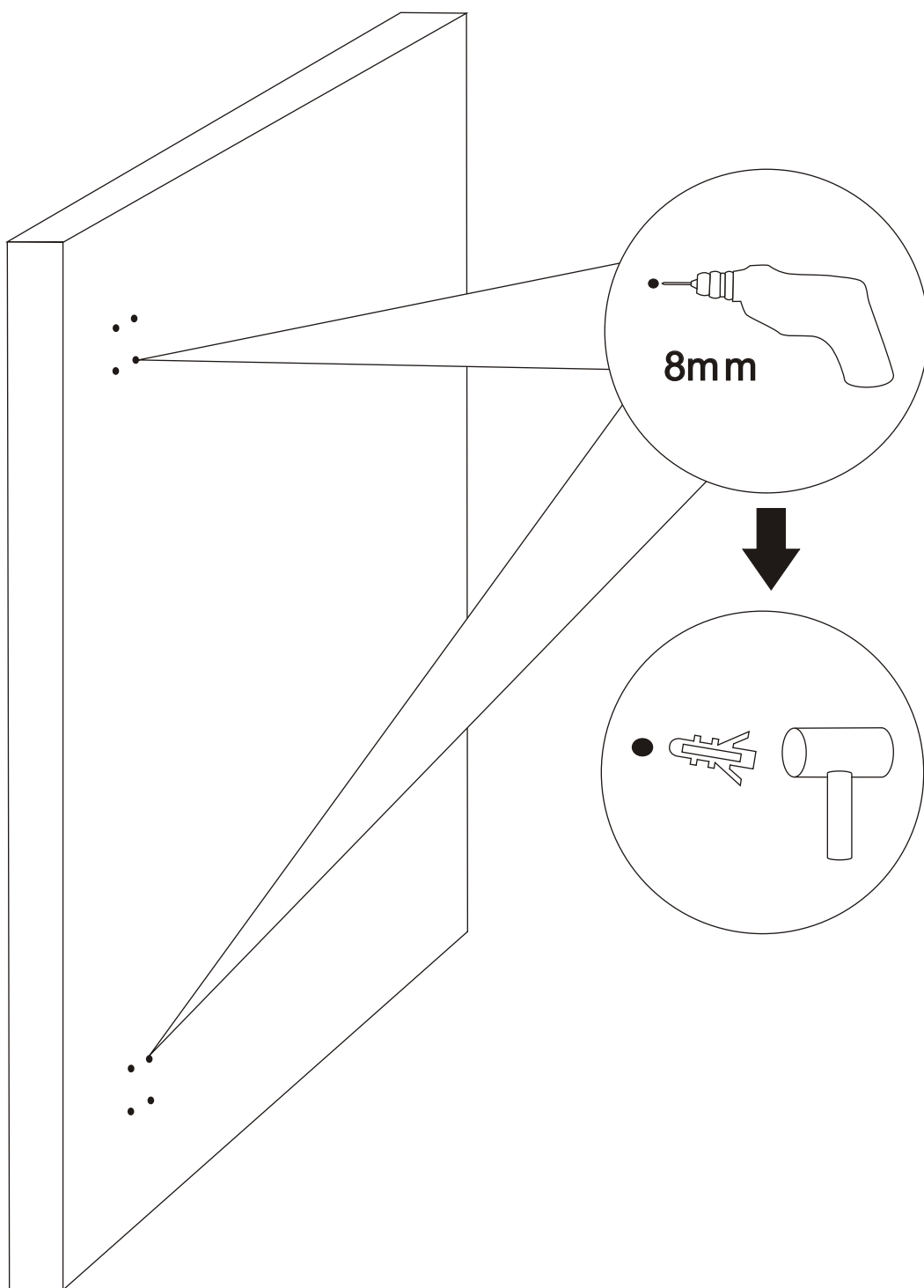
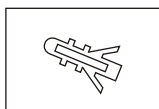
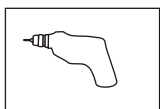

Installieren Sie die Nischentür wie abgebildet und verschrauben Sie den Türknopf

