

3458/3459

**RoHS** **CE** **ISO9001:2000**

## Benötigtes Werkzeug

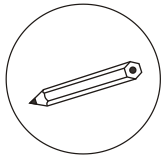

Bleistift

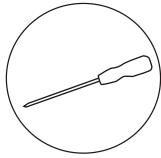

Schraubendreher(Kreuz)

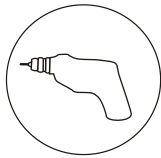

Bohrmaschine

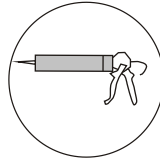

Silikongel

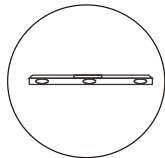

Wasserwaage

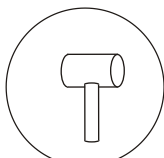

Gummihammer

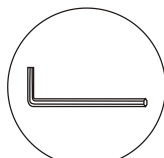

Imbusschlüssel

## Teileliste

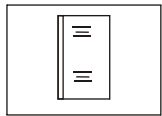

Glass

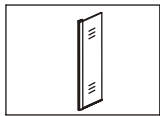

Glass

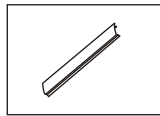

Side cover

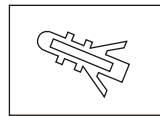

Expand tube

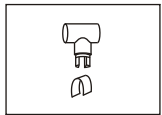

PJ-4416

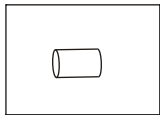

PJ-4451

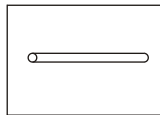

LG-2004

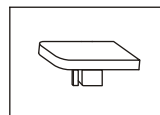

PJ-4509

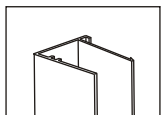

Wall profile

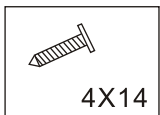

Screw

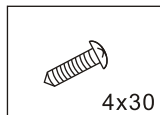

Screw

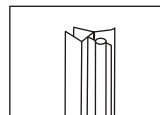

water-proof gasket

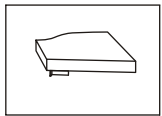

PJ-4514/  
PJ-4515

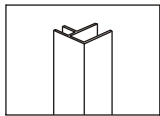

WL-684

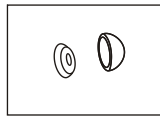

PJ-4553

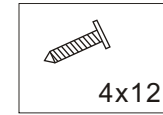
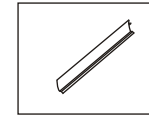
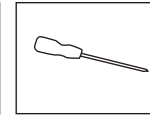
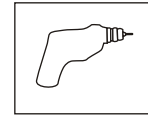

4x12

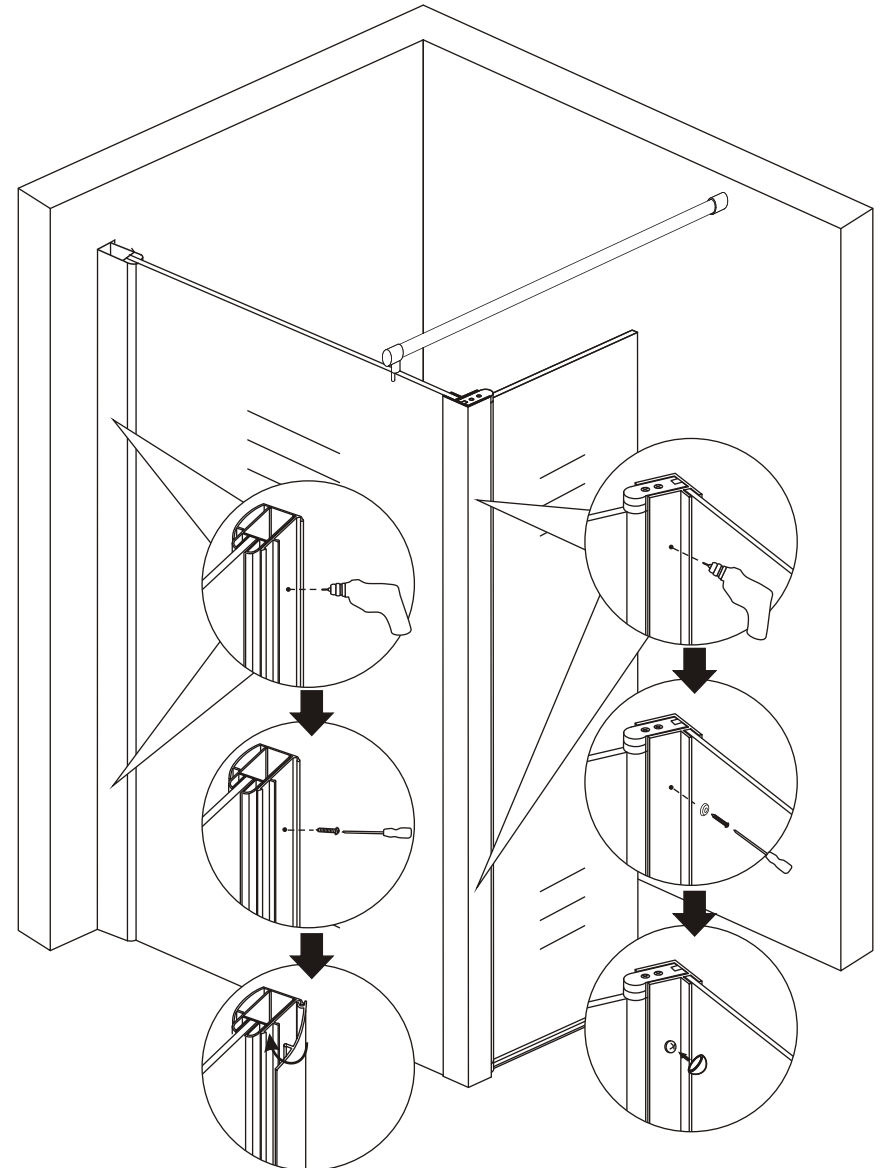

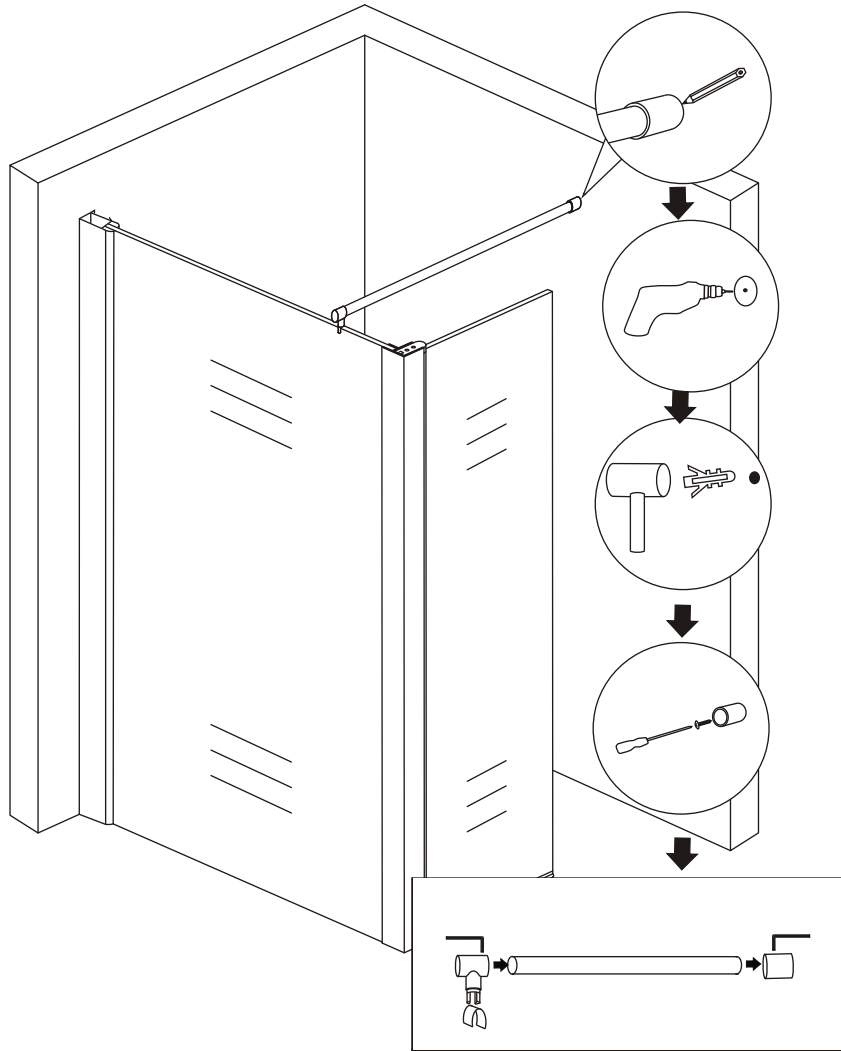
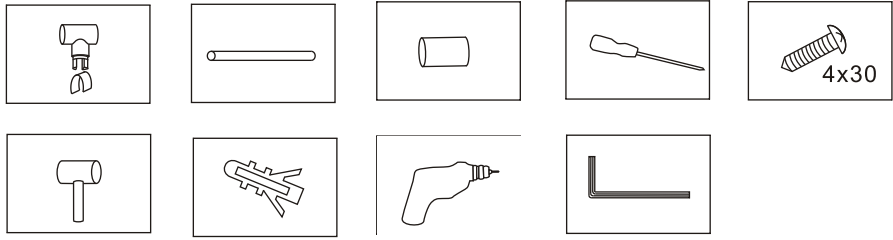

5

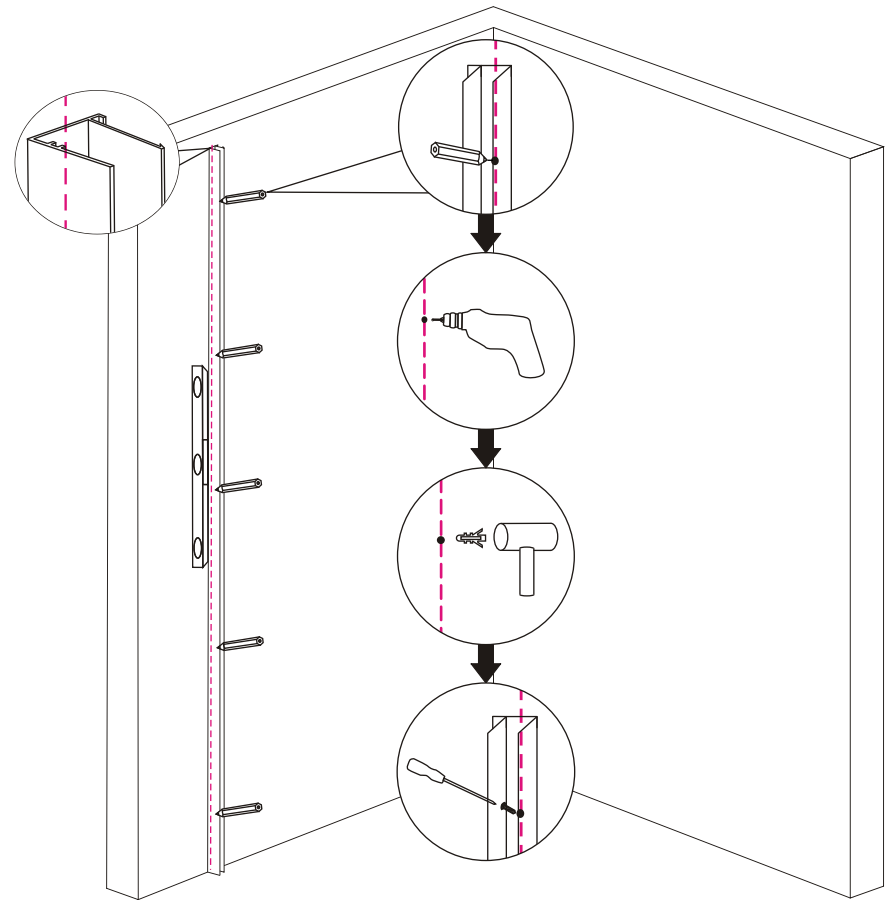
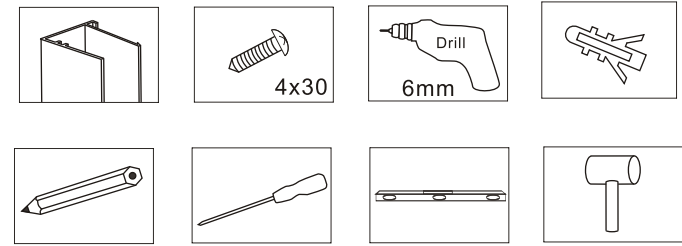

2

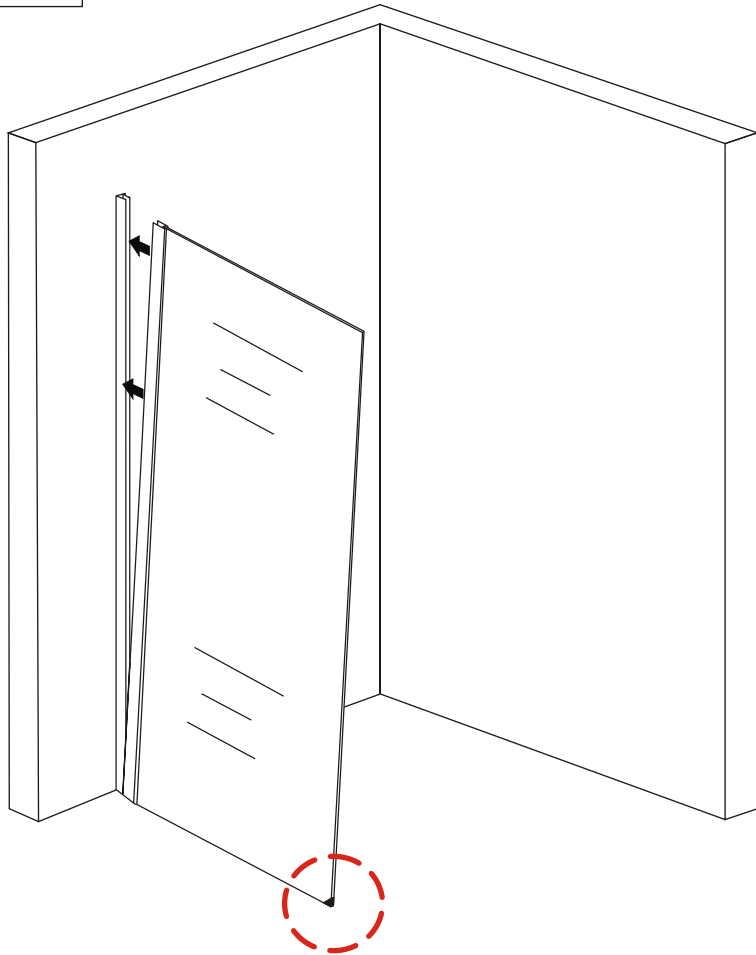
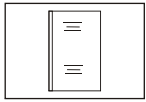

3

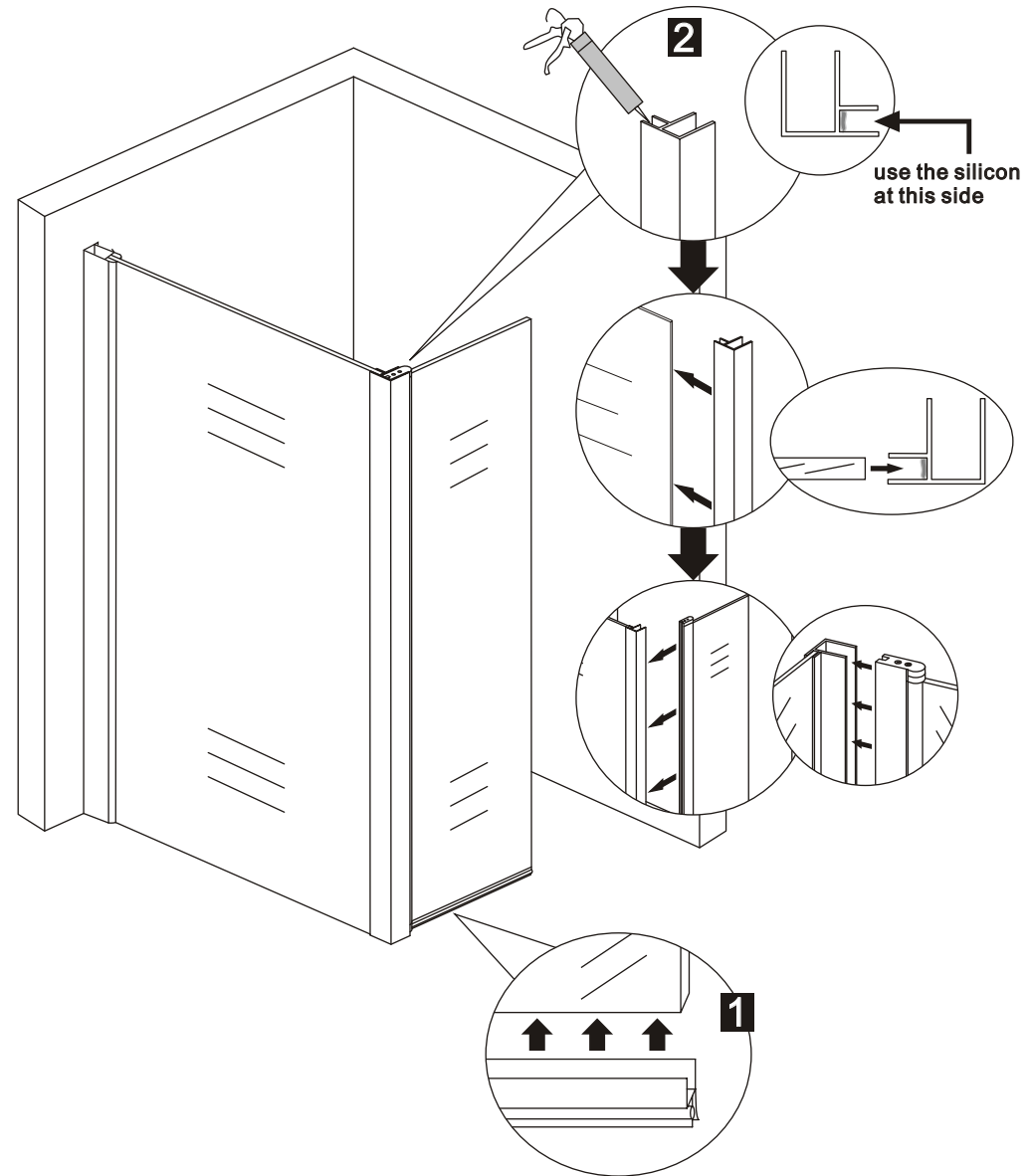
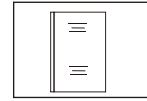

4