

3454

**RoHS** **CE** **ISO9001:2000**

## Benötigtes Werkzeug

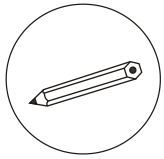

Bleistift

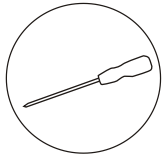

Schraubendreher(Kreuz)



Bohrmaschine

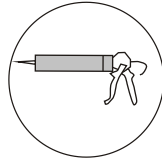

Silikongel

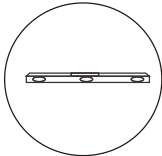

Wasserwaage

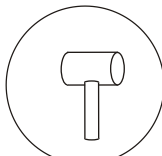

Gummihammer

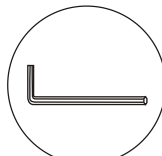

Imbusschlüssel

## Teileliste

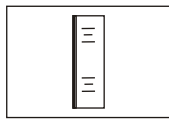

Glass

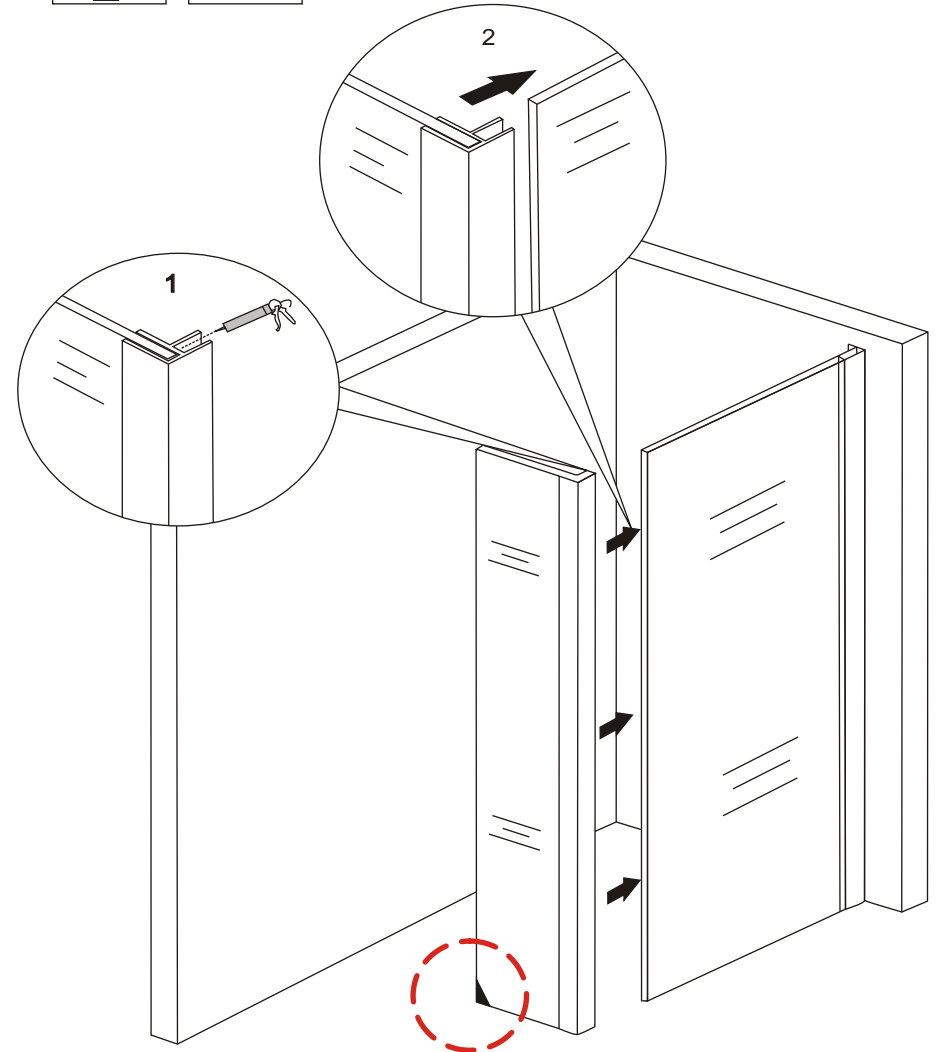
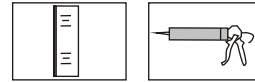

1

2